

貼り合わせ図

1	2
3	4
5	6

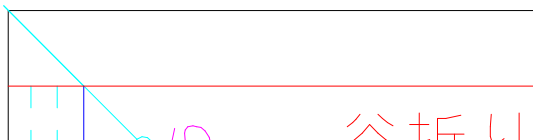

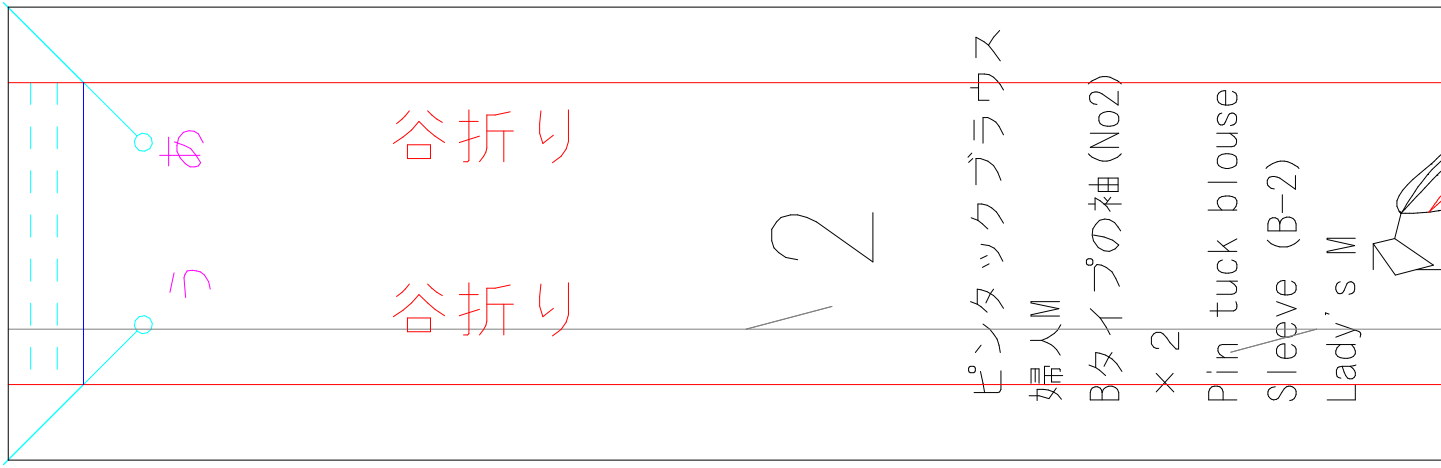

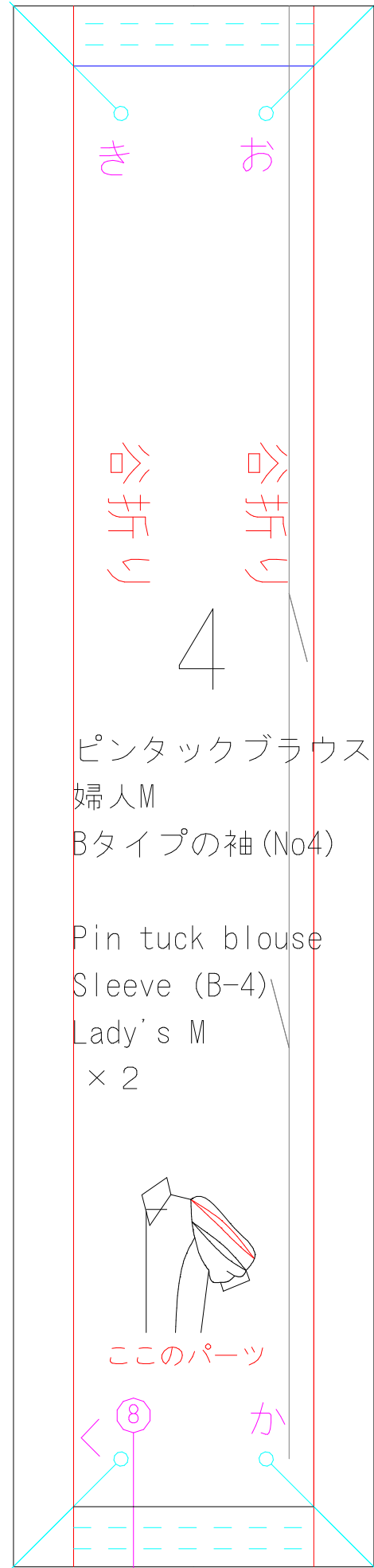
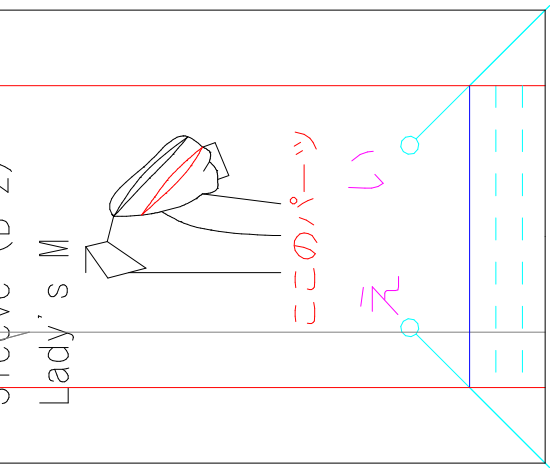
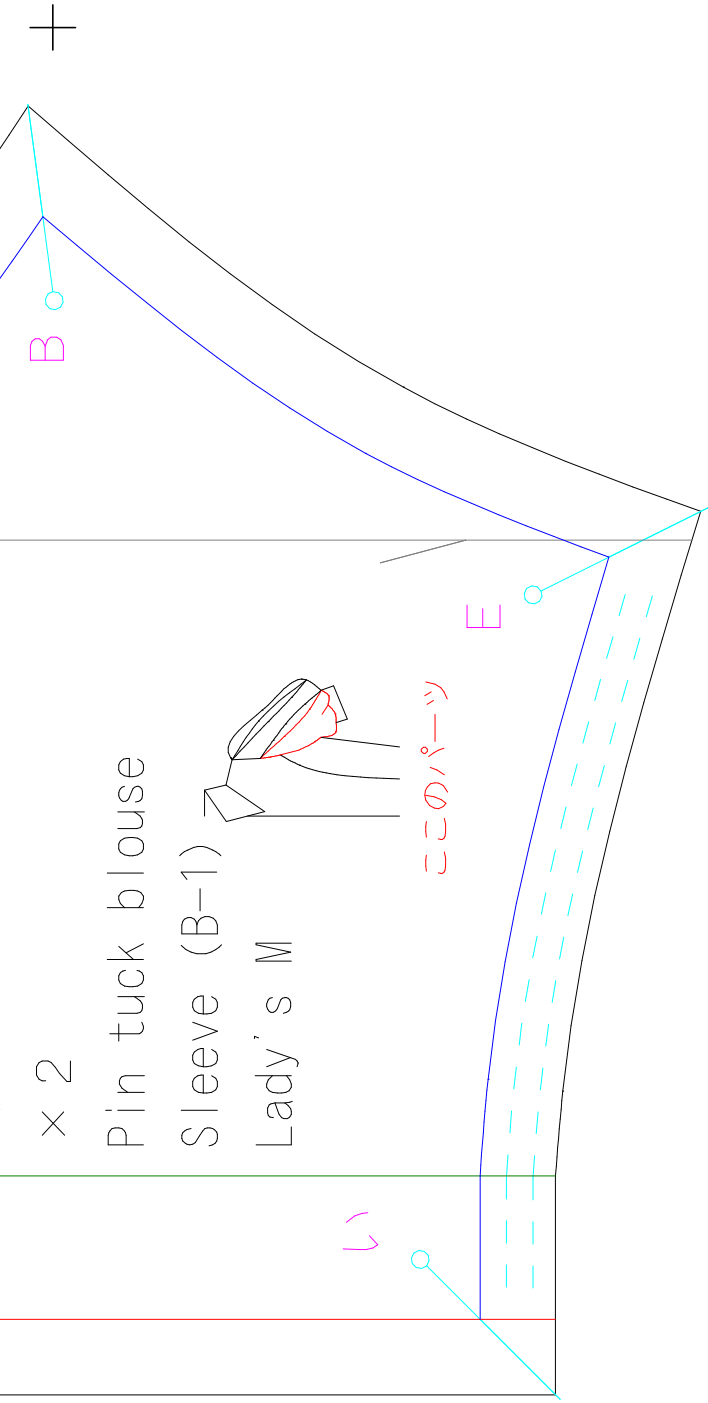
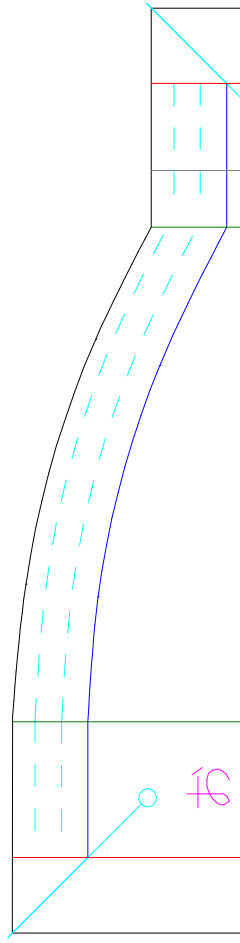

谷折り

山折り

3

山折り

谷折り

ピンタックブラウス
 婦人M
 Bタイプの袖 (No3)
 × 2
 Pin tuck blouse
 Sleeve (B-3)
 Lady's M

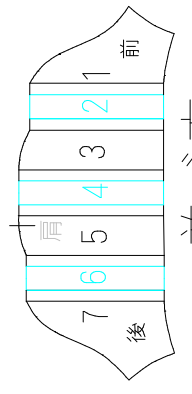

並べ方

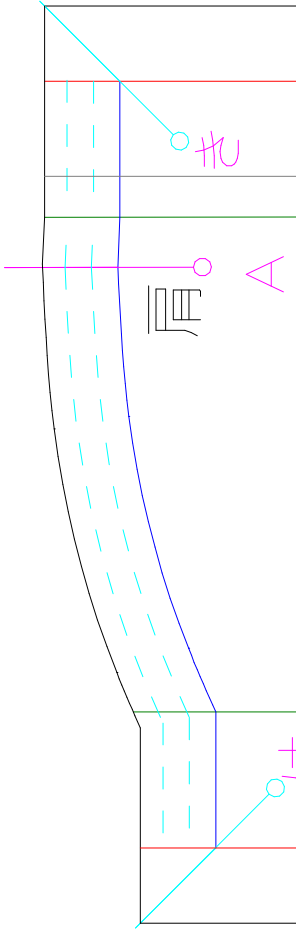

谷折り

山折り

5

山折り

谷折り

ピンタックブラウス
 婦人M
 Bタイプの袖 (No5)
 × 2
 Pin tuck blouse
 Sleeve (B-5)
 Lady's M



Sleeve (B-5)
Lady's M

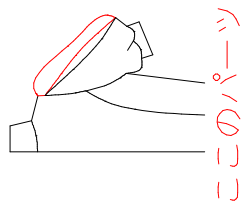

こ

く

か

このパーツ

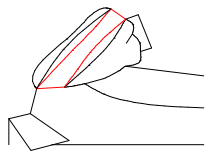

並べ方

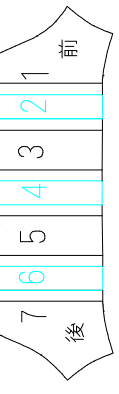

え

<4>

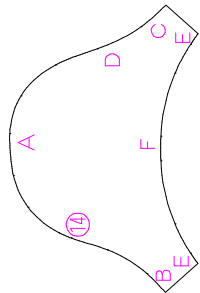

E F E

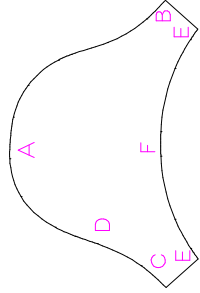

E F E

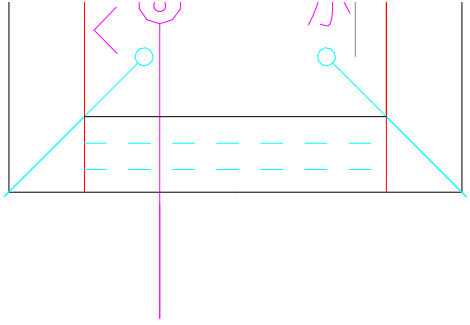
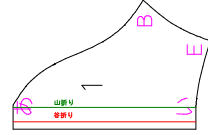
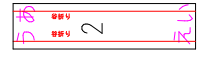
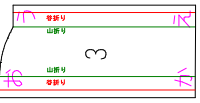
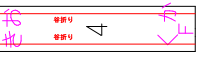
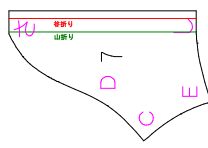

内そではピンタックブラウスに入っています



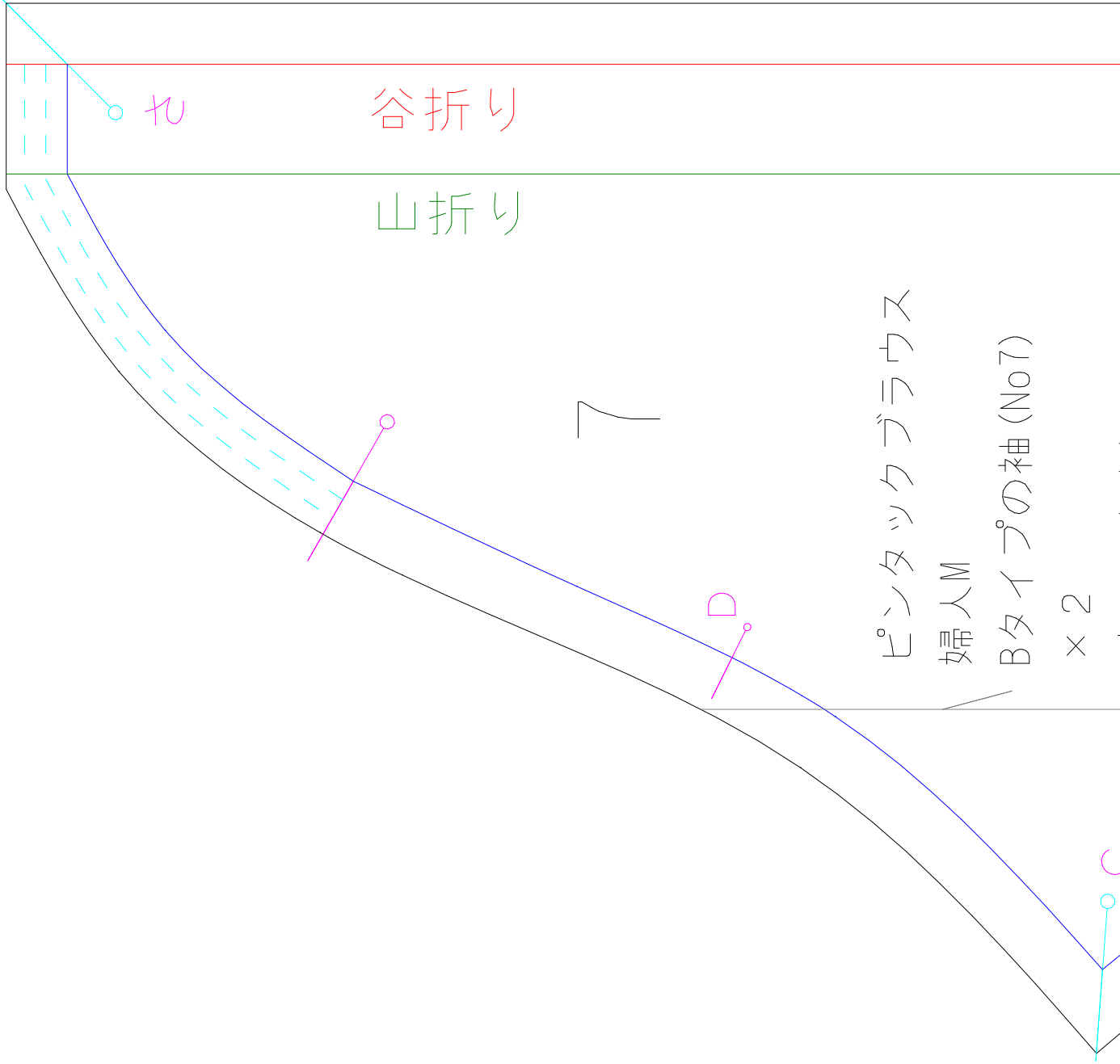
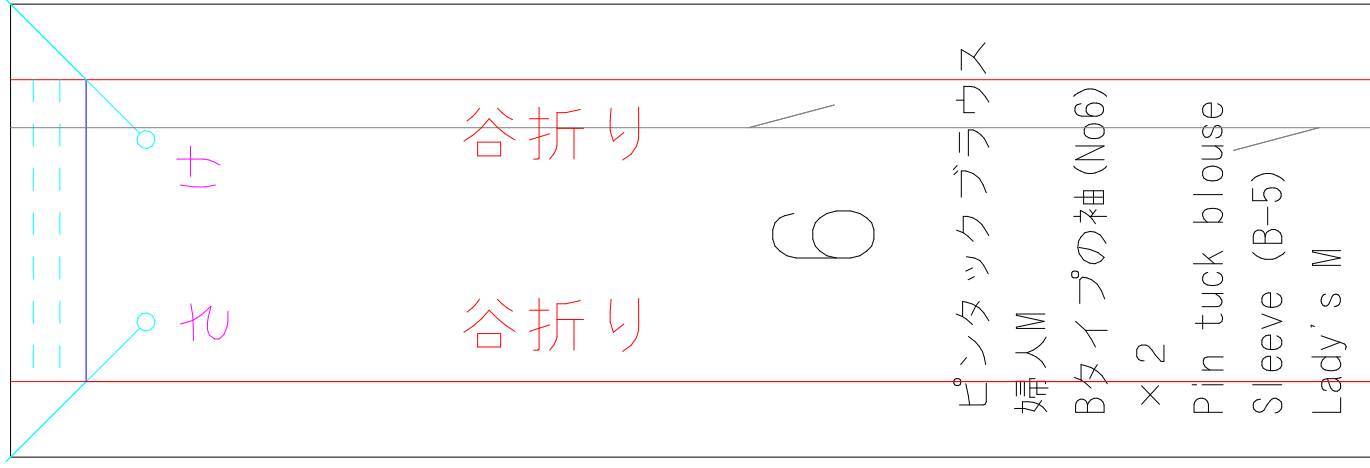

Bタイプの袖 (No7)

× 2

Pin tuck blouse

Sleeve (B-7)

Lady's M

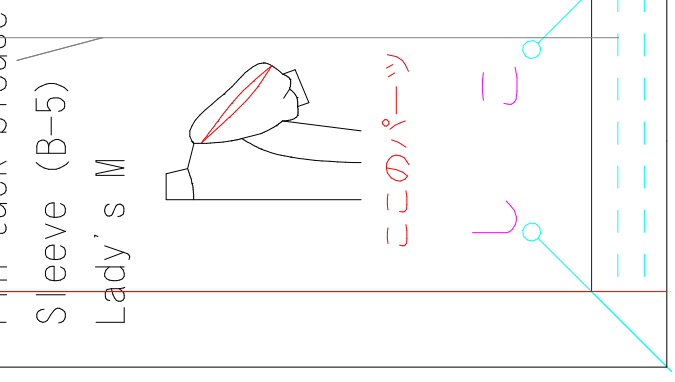
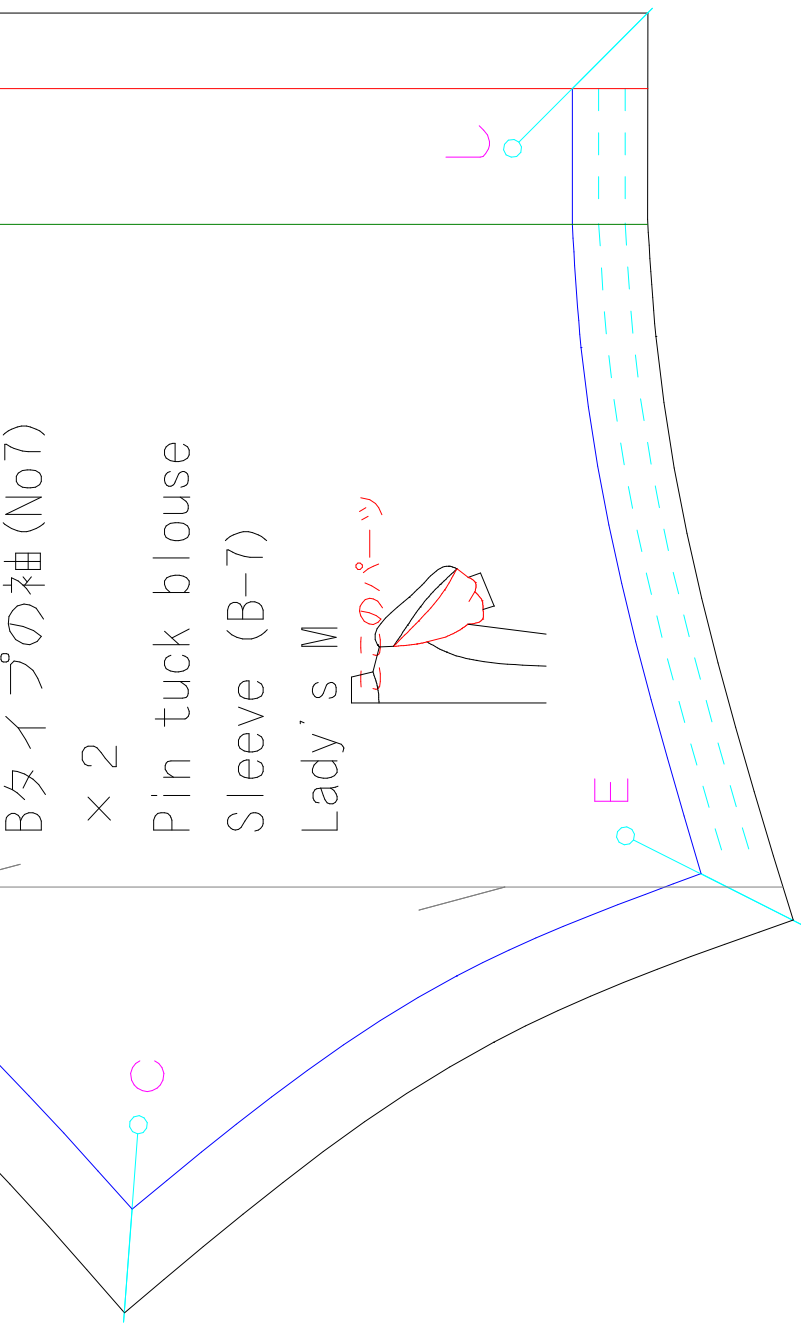
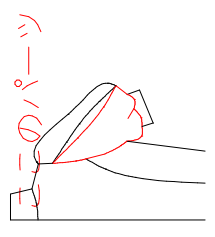

Sleeve (B-5)
Lady's M

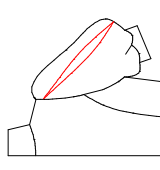

このパーツ



< 6 >

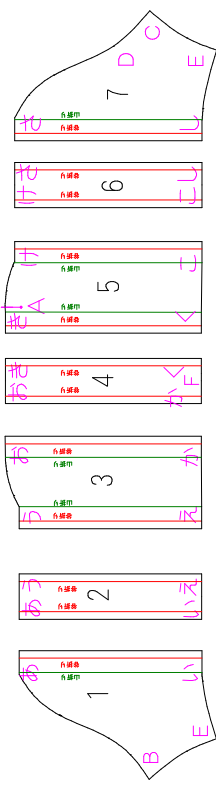

内

