

1	3	5	7
2	4	6	8

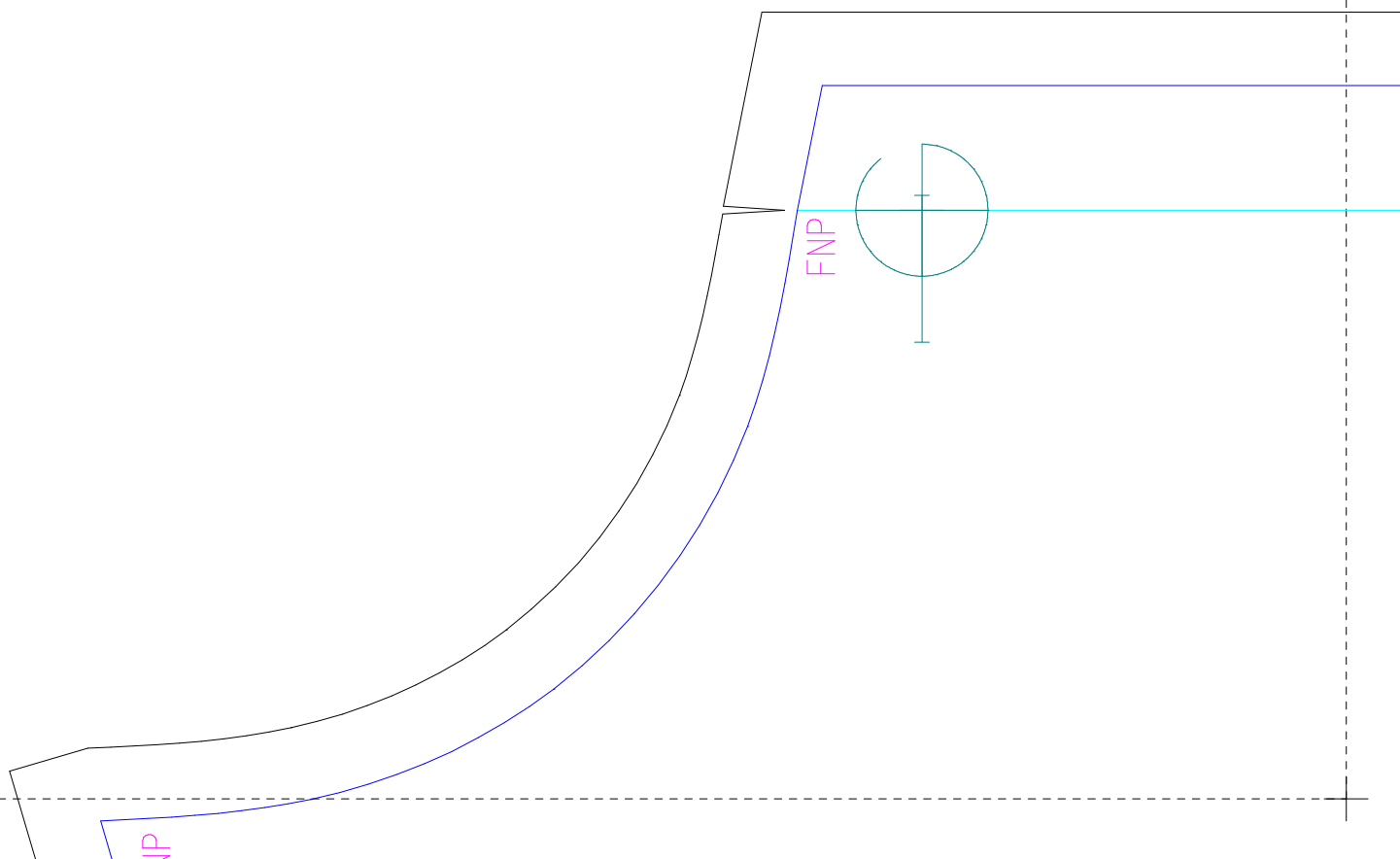

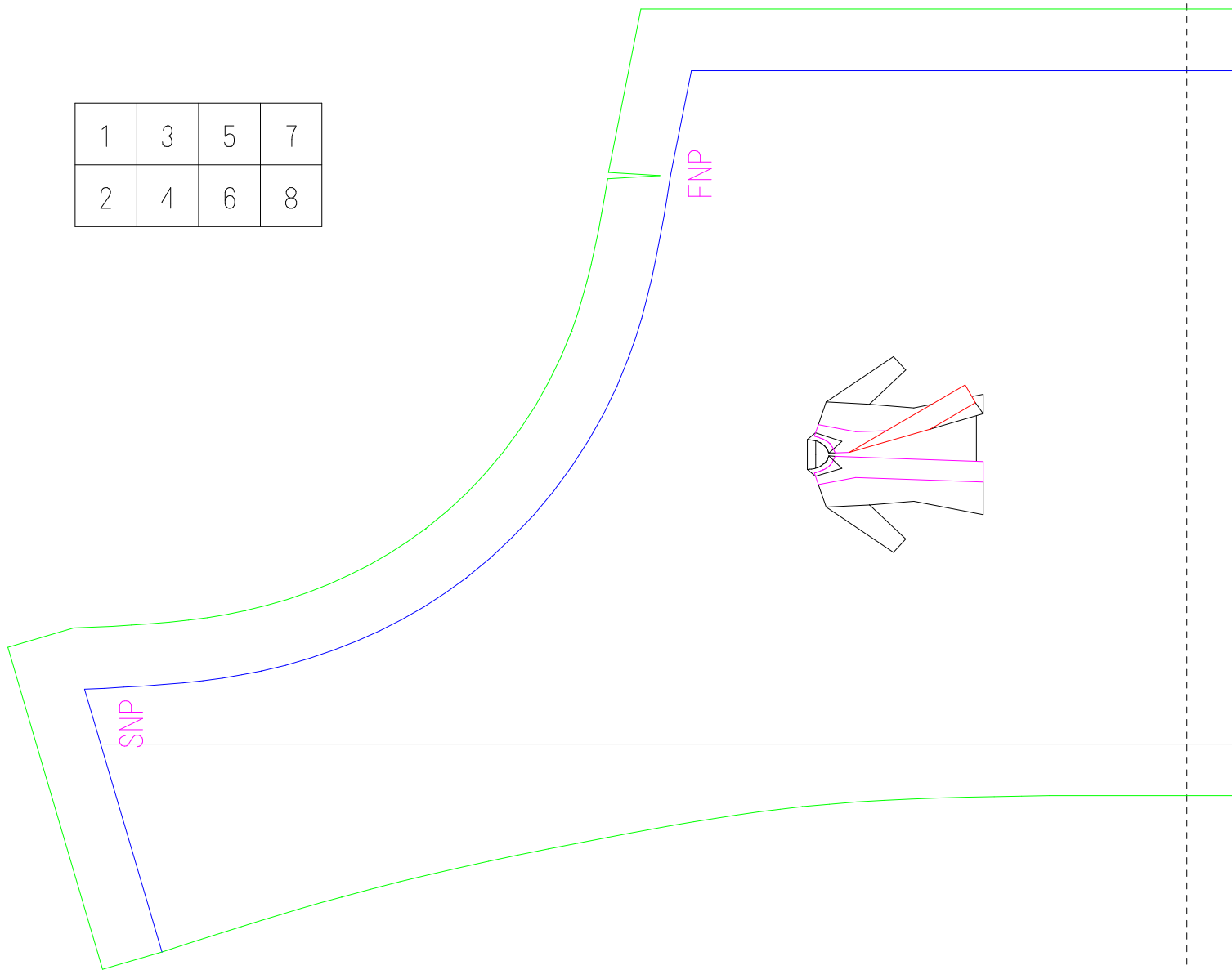
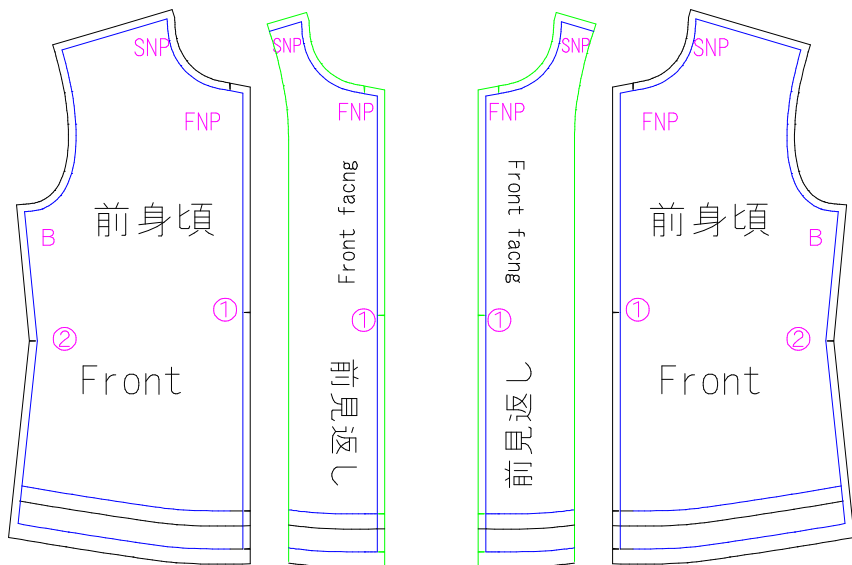
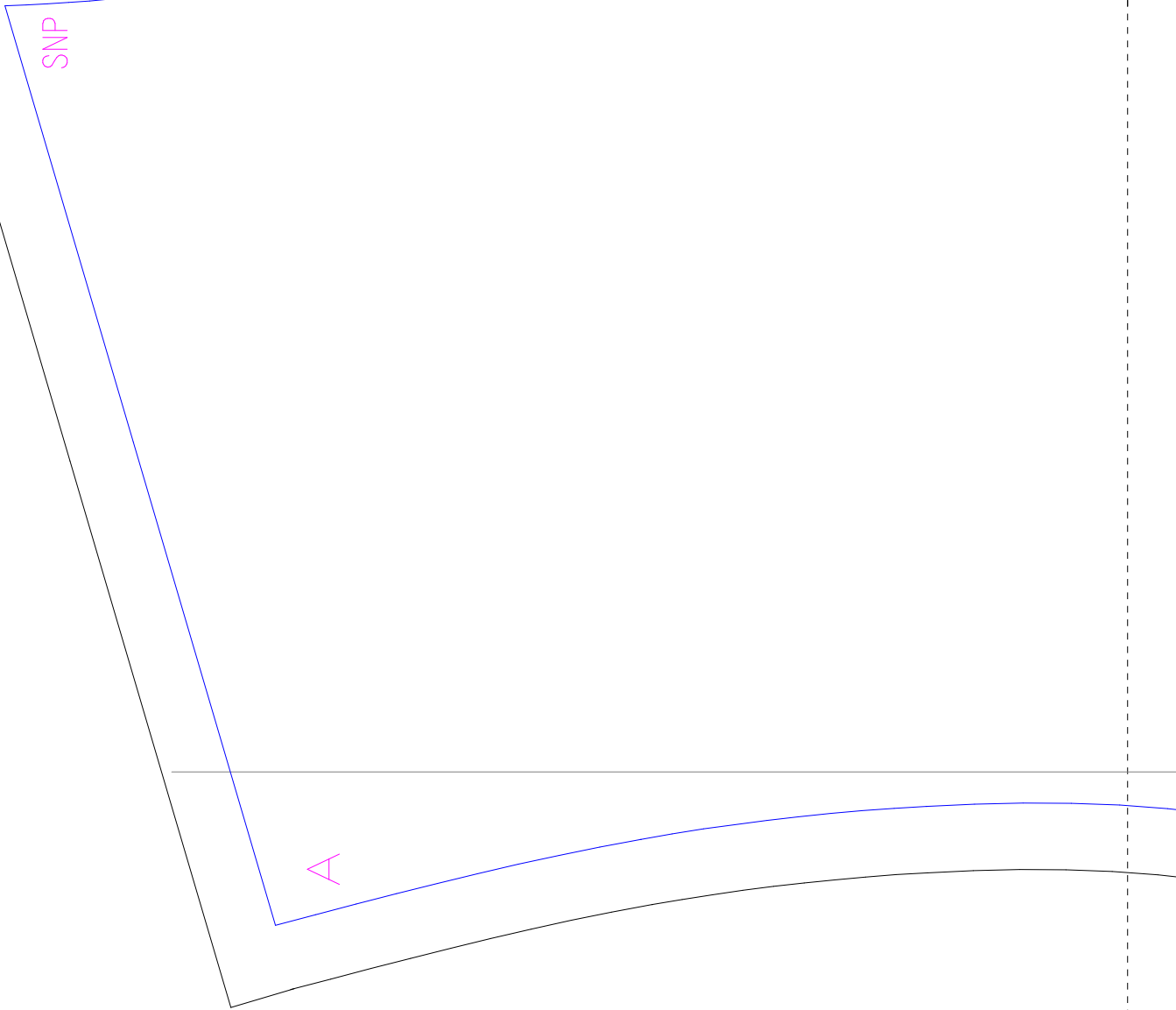

シャツカラーつきジャケット

前見返し

左右対称に2枚

婦人 LL

Shirt collar of Jacket

Front facng

× 2 (bilateral symmetry)

Lady' s LL

接着芯を貼る

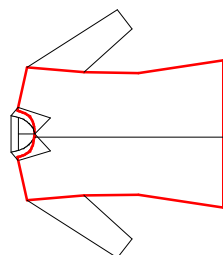
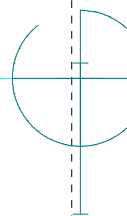
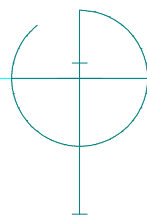
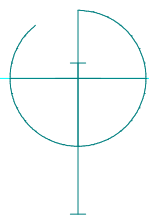

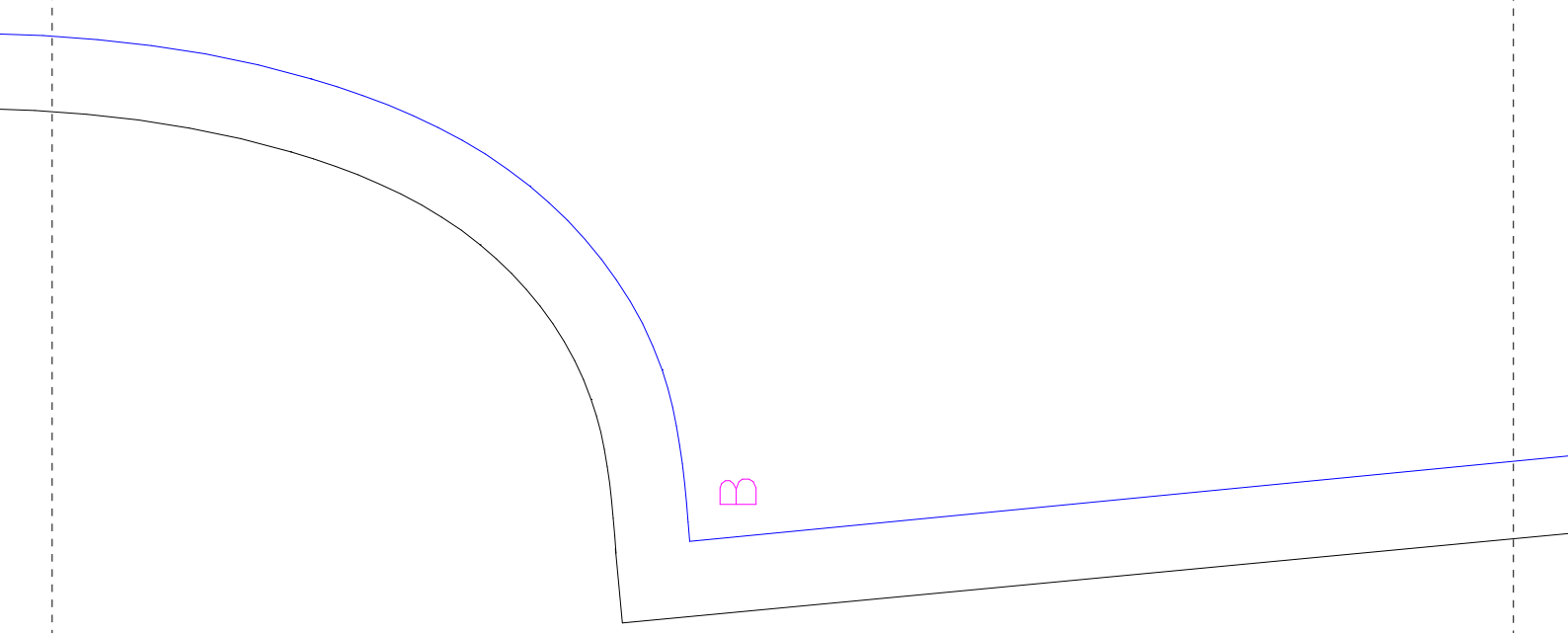

シャツカラーつきジャケット

前身頃

左右対称に2枚

婦人 LL

Shirt collar of Jacket

Front

× 2 (bilateral symmetry)

Lady's LL

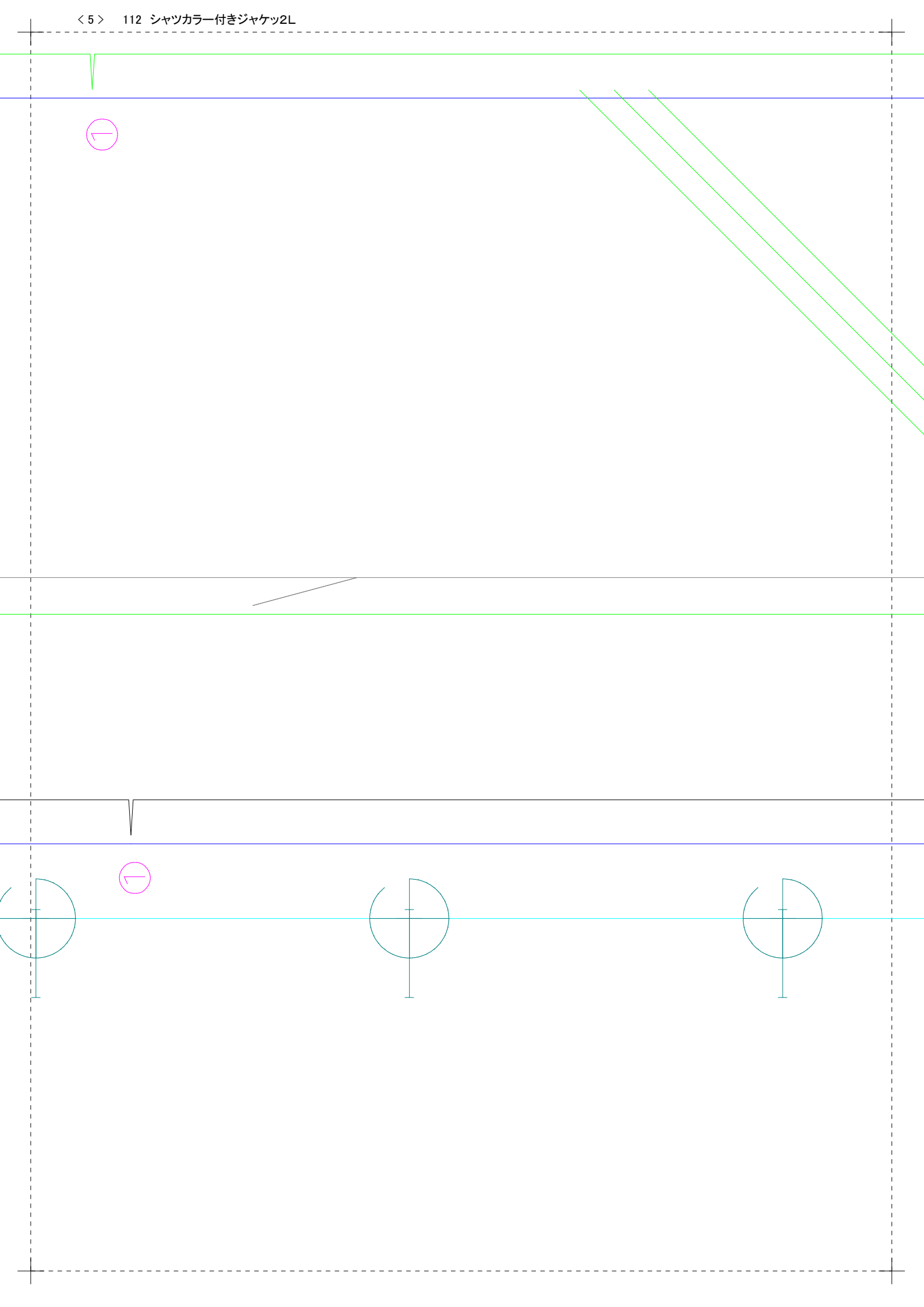

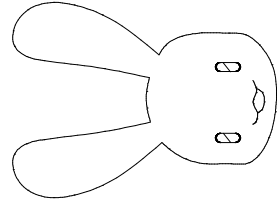

手作り服の作り方と型紙
USAKOの洋裁工房
<http://yousai.net/>

②

