

1	3	5	7
2	4	6	8

シャツカラーつきジャケット
前見返し
左右対称に2枚

婦大-M

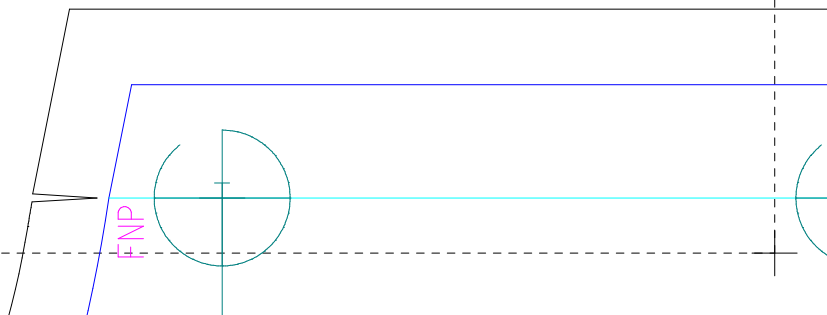

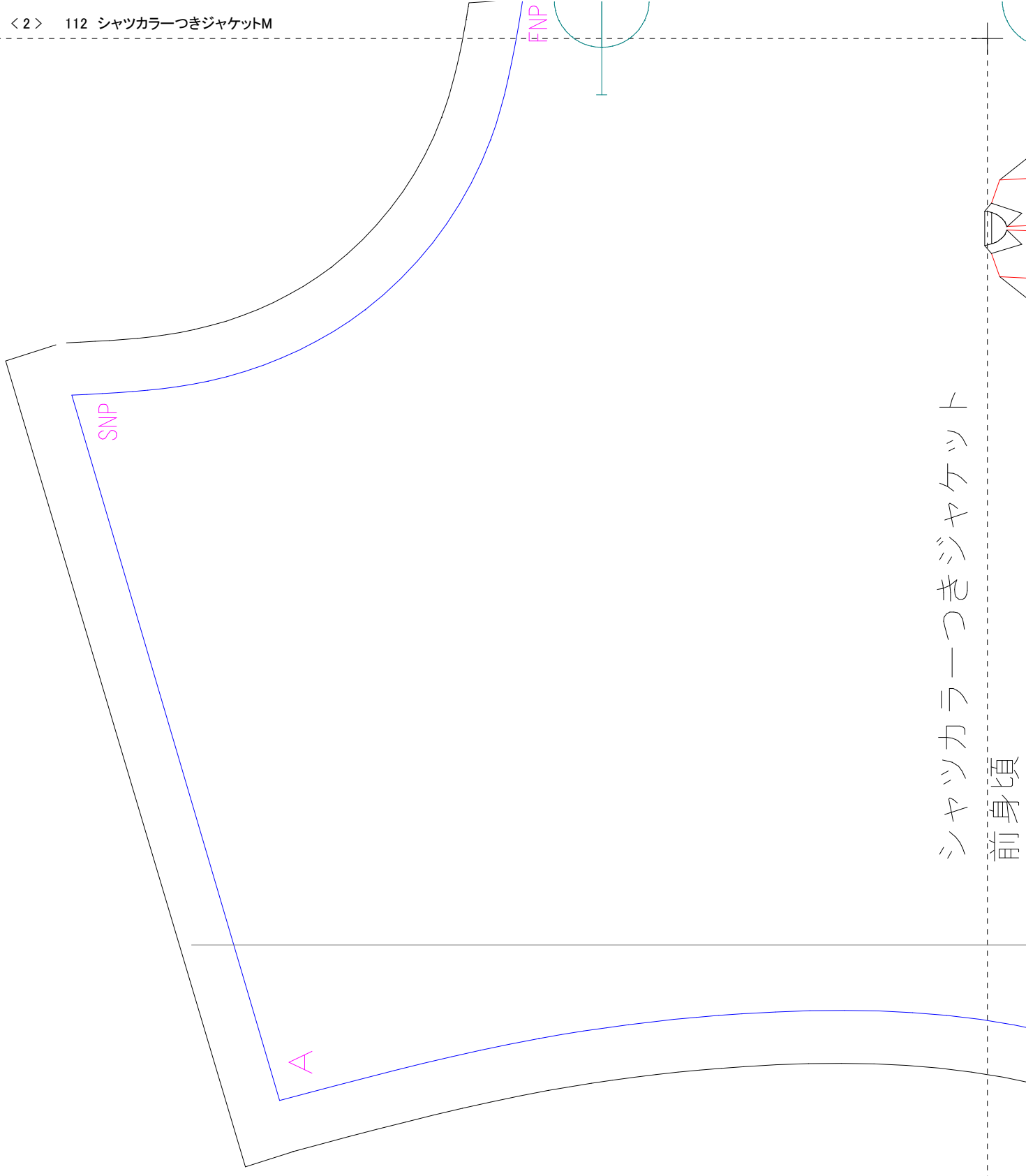

シャツカラーつきジャケット

前身頃

江口 対称 (左右)

婦大 M

Shirt collar of Jacket

Front facng

× 2 (bilateral symmetry)

M size

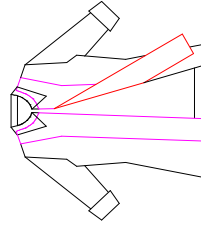

接着芯を貼る

①

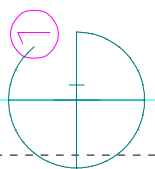
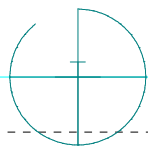
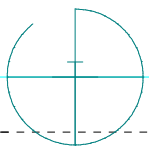

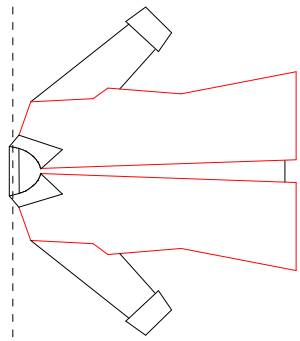

前身頃

左右対称に2枚

婦人 M

Shirt collar of Jacket

Front

× 2 (bilateral symmetry)

M size

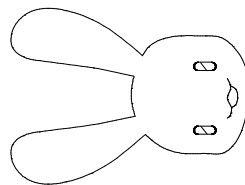

手作り服の作り方と型紙
 USAKOの洋裁工房
<http://yousai.net/>

B

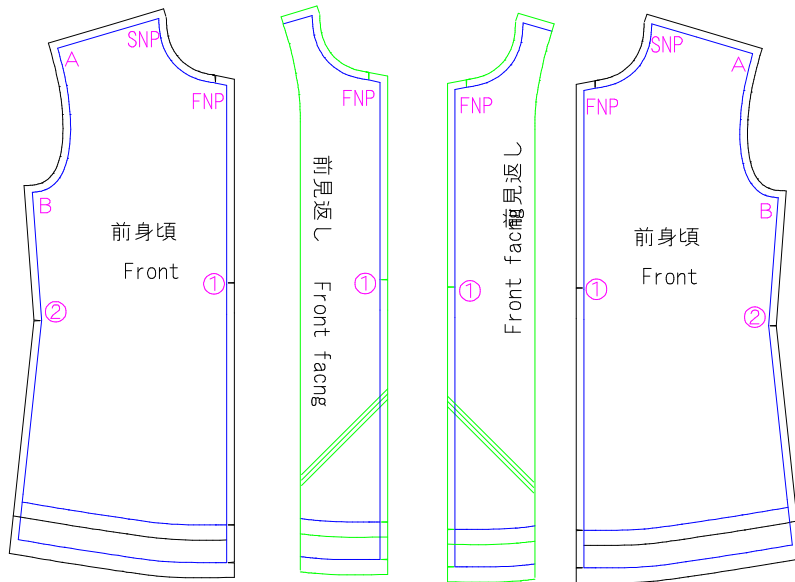

ボタンの市は目安です
作りたいデザインに合わせて
自由に数や間隔を変えてください

この線がボタンの位置の基準です→

②

