

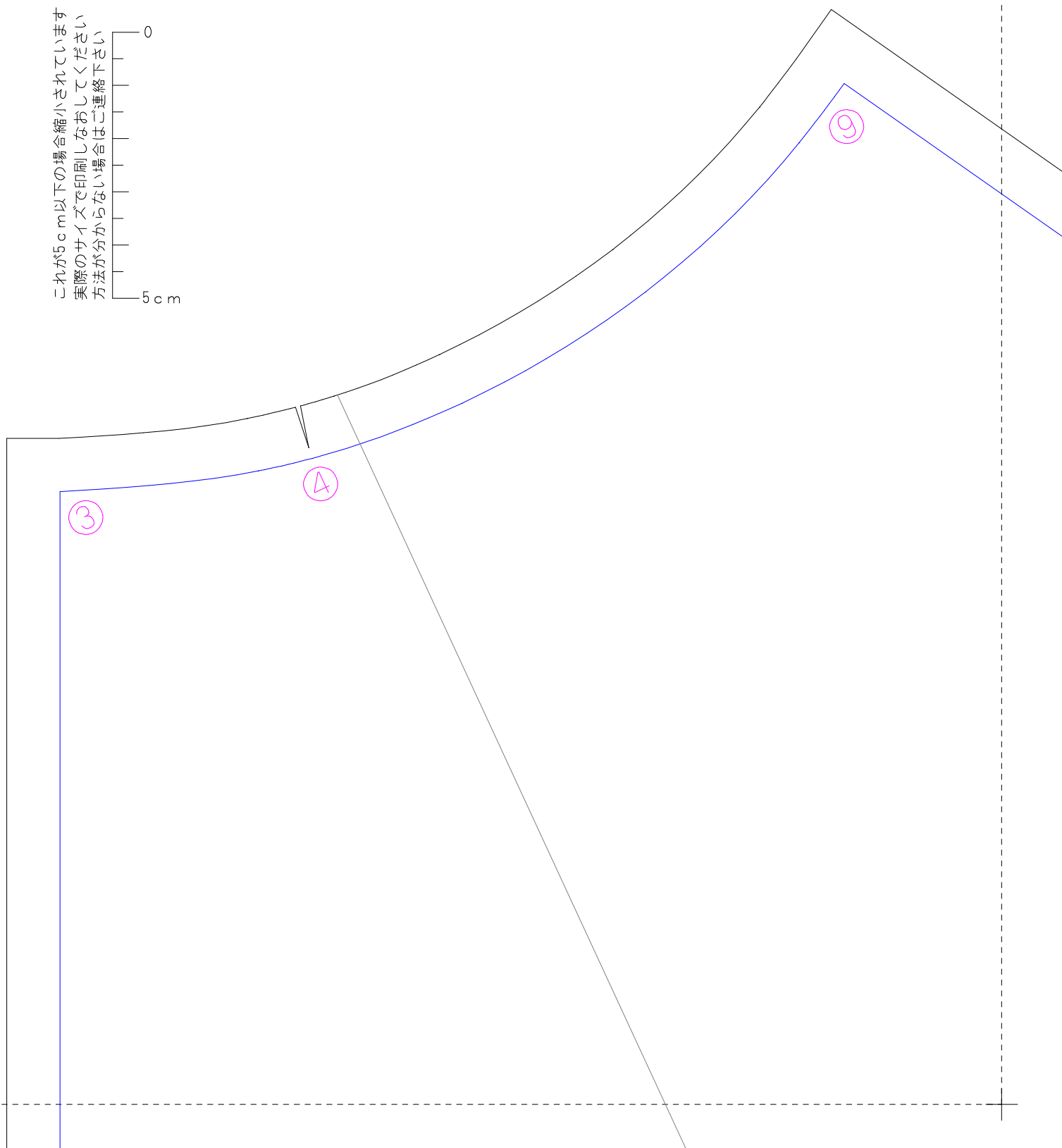

1	4	7	10	13	16	19	22
2	5	8	11	14	17	20	23
3	6	9	12	15	18	21	24

この図のように
貼り合せてください
先に貼り合わせてから
切ってください

これが5cm以下の場合縮小されています
実際のサイズで印刷しなおしてください
方法が分からない場合はご連絡下さい



⑤

⑥

前フリルスカート
出来上がりウエスト69cm
後スカート
左右対称に2枚

①

⑧

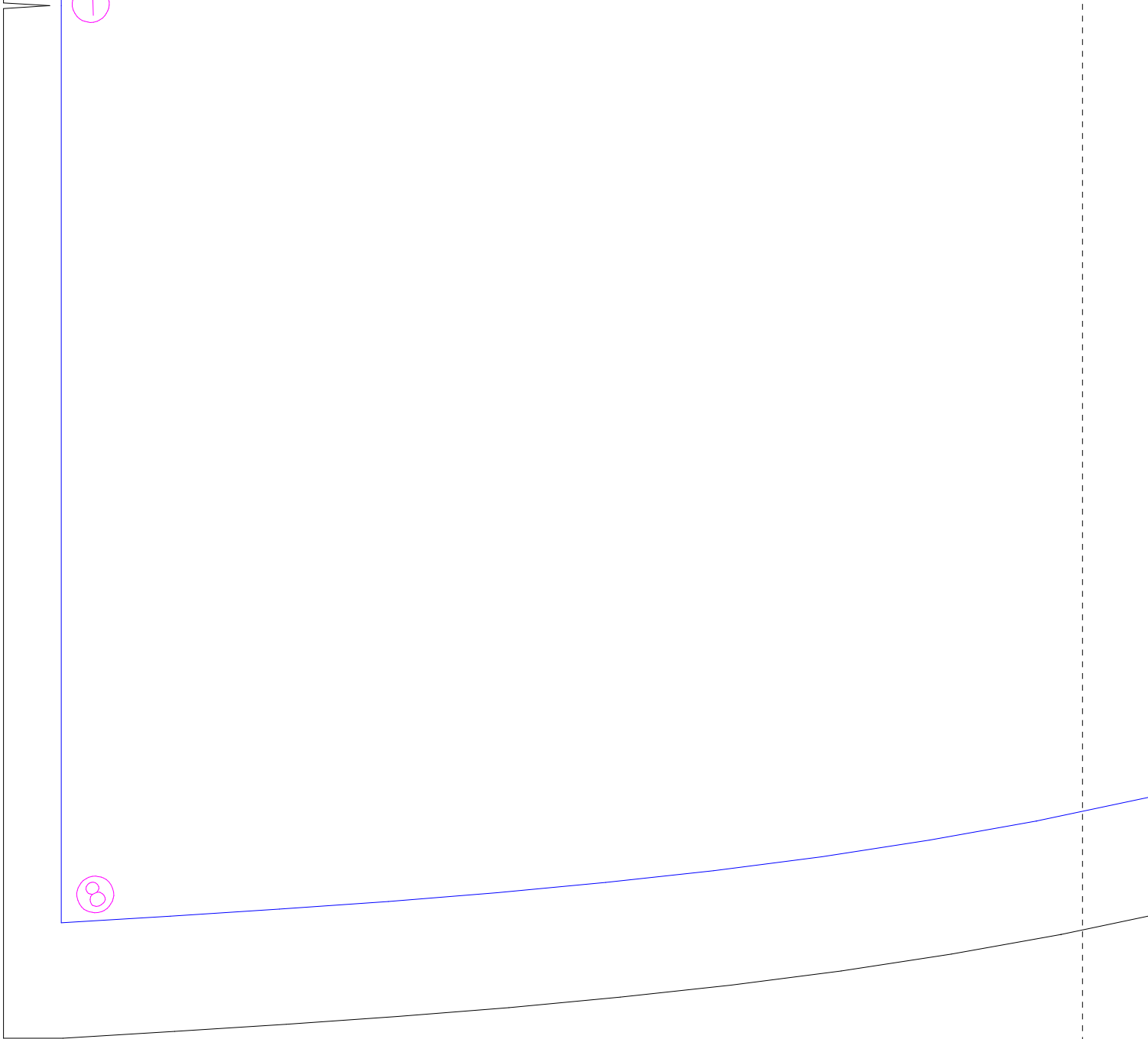

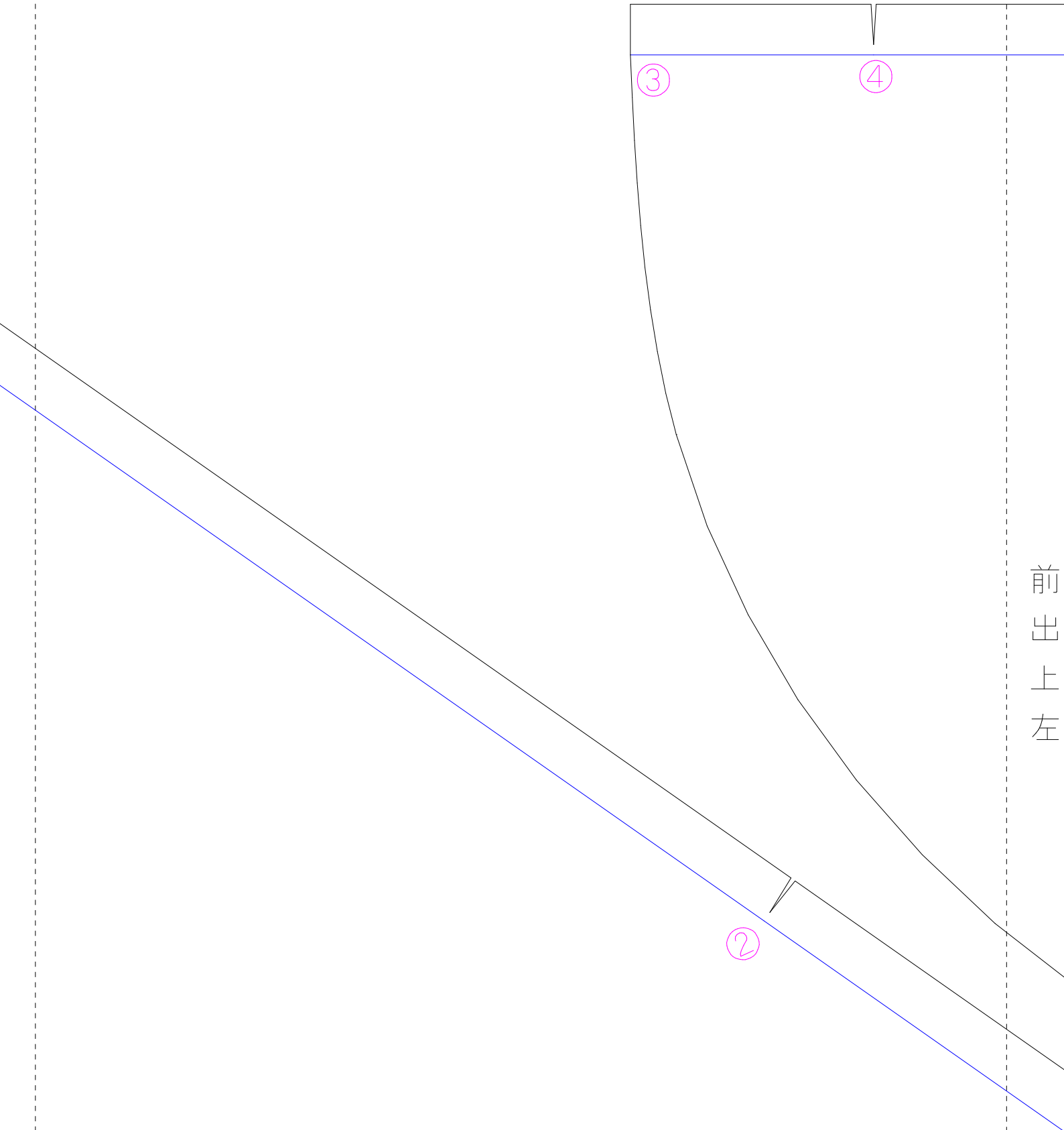

前出上左

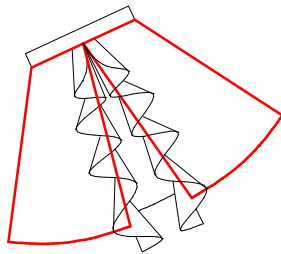

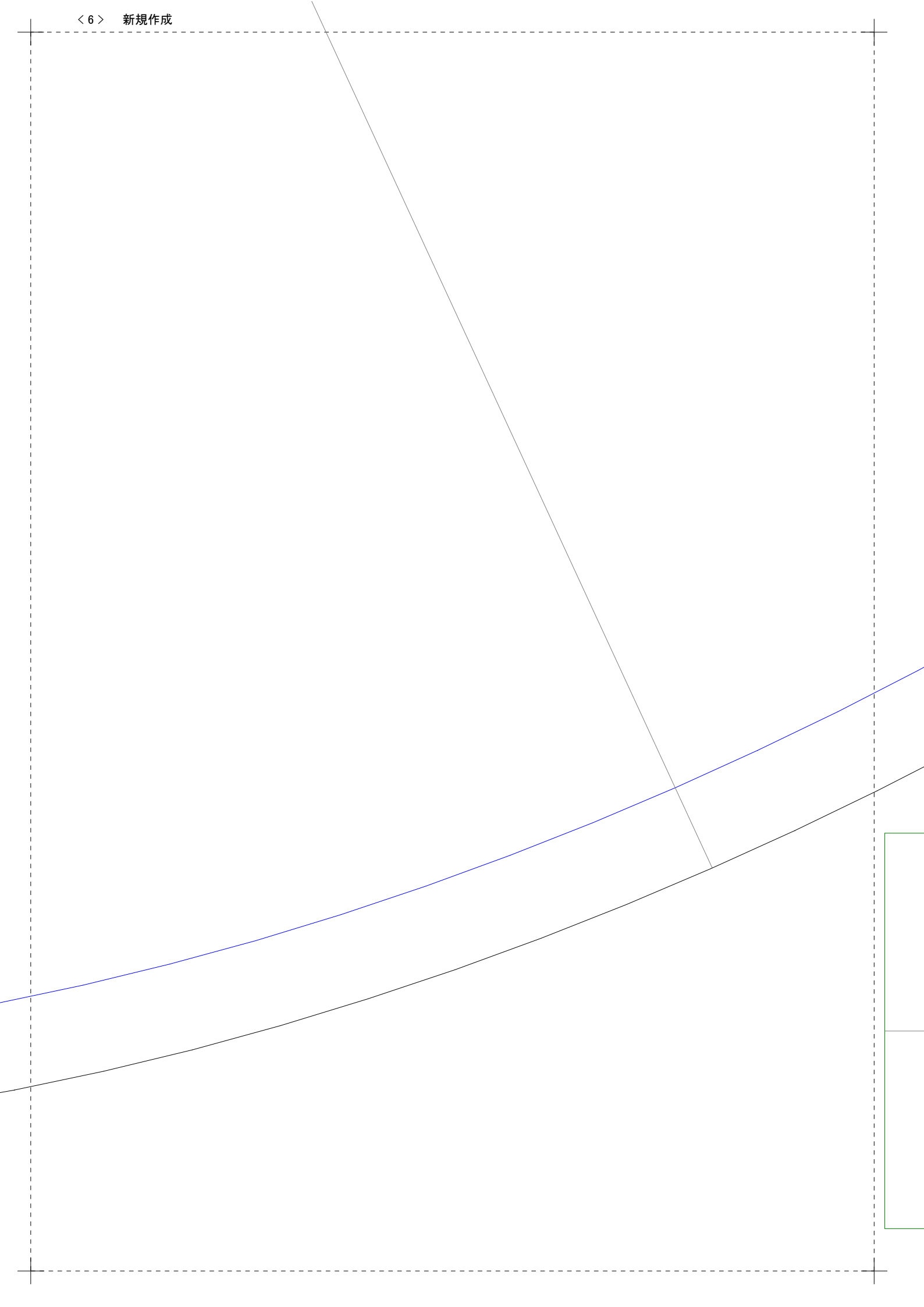

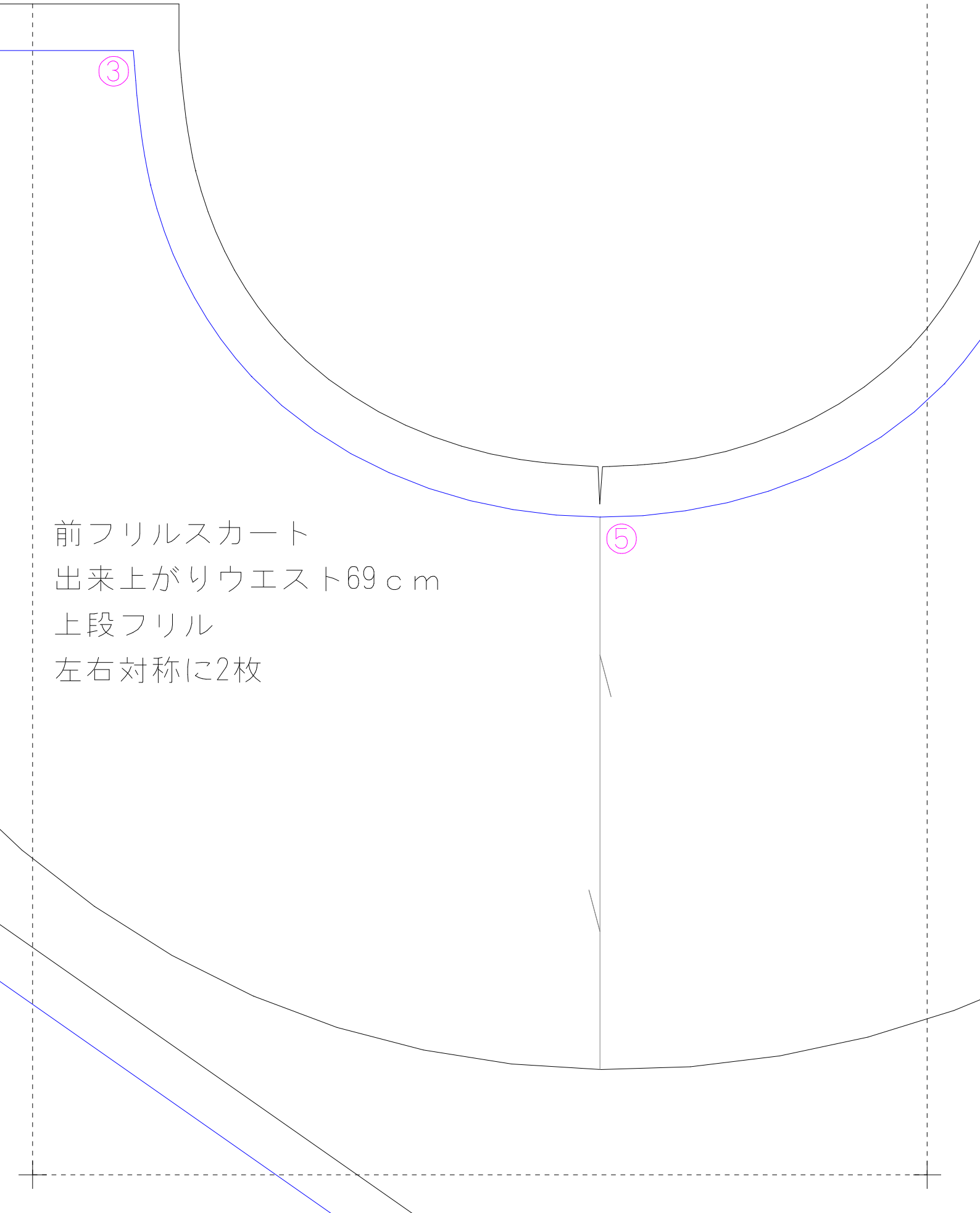

③

⑤

前フリルスカート
出来上がりウエスト69cm
上段フリル
左右対称に2枚

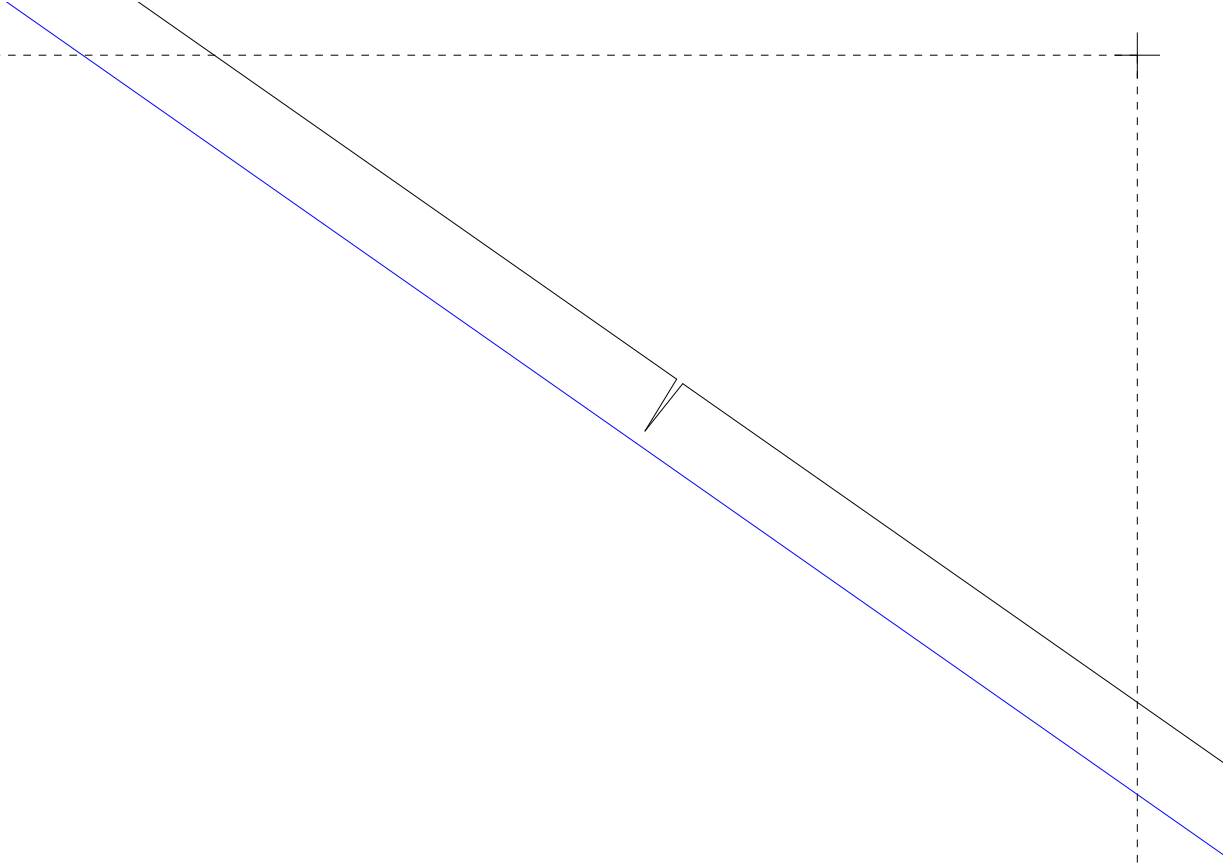

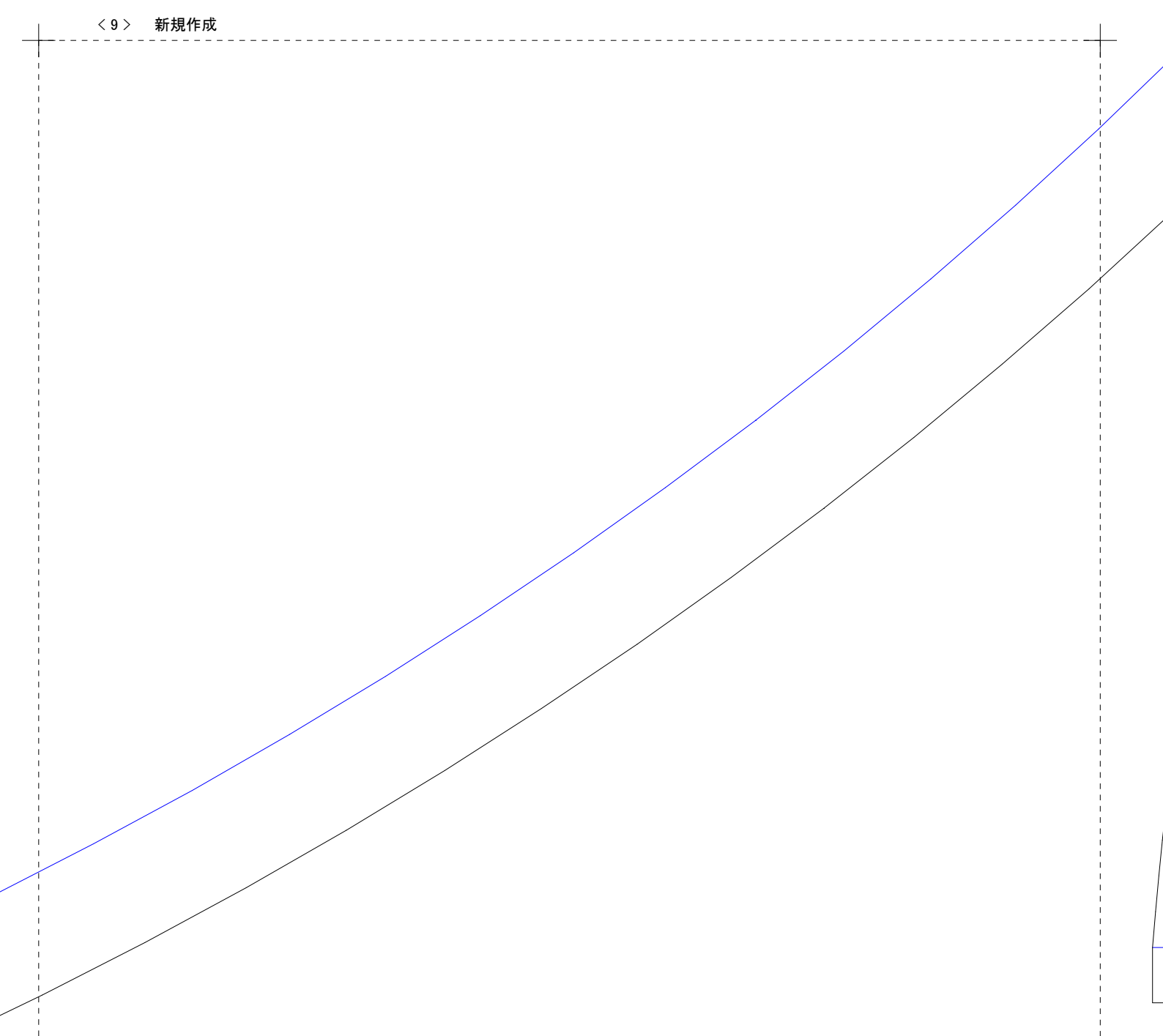

⑩

かぎホックを
つけるための
重なり分

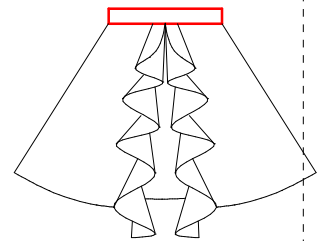

かぎホック

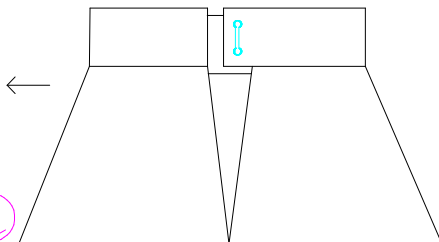

⑪

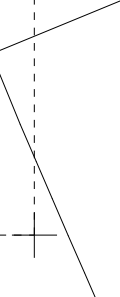
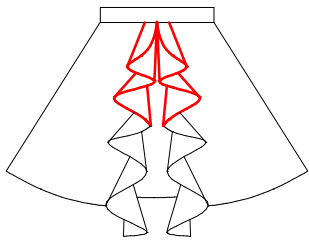
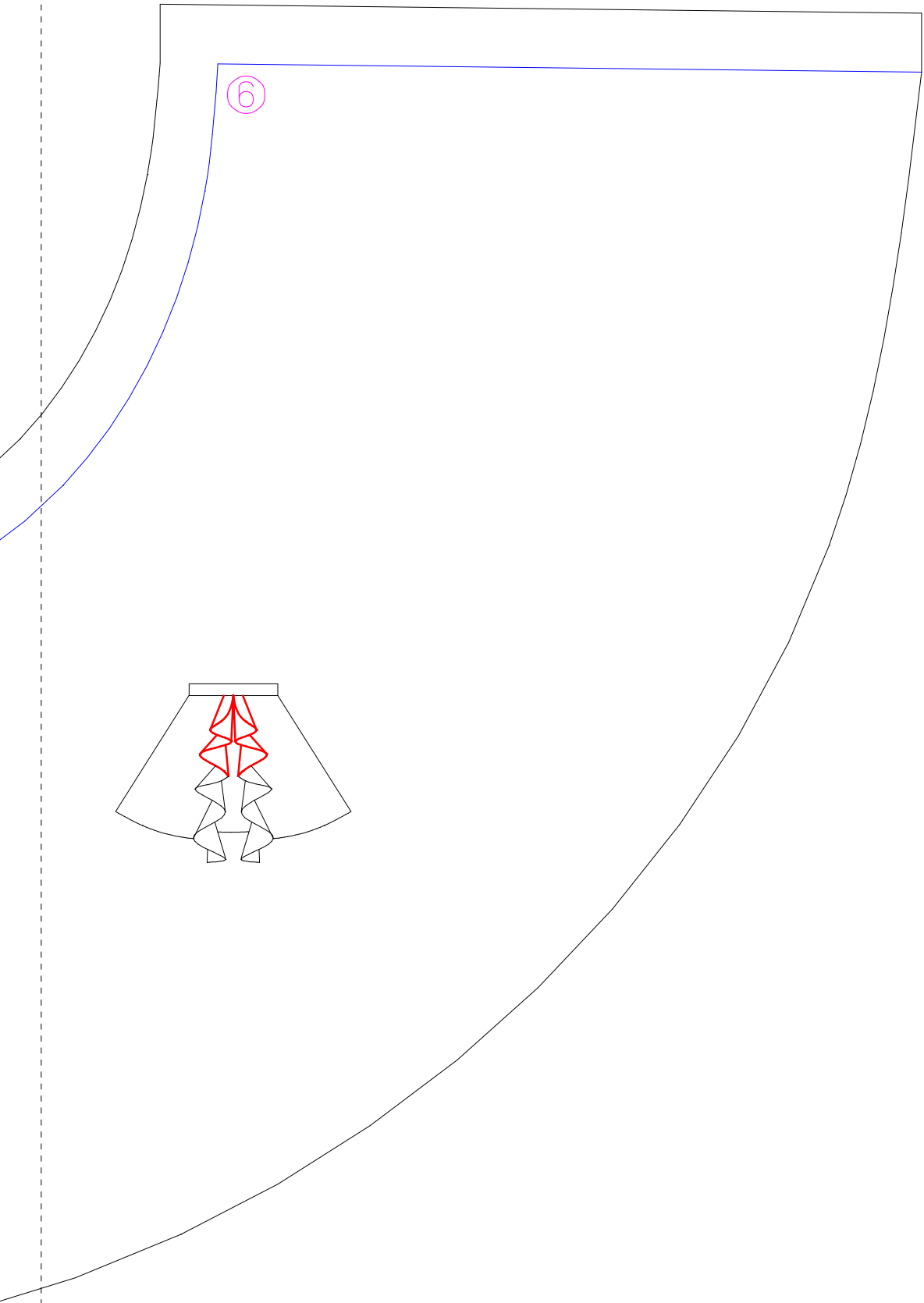

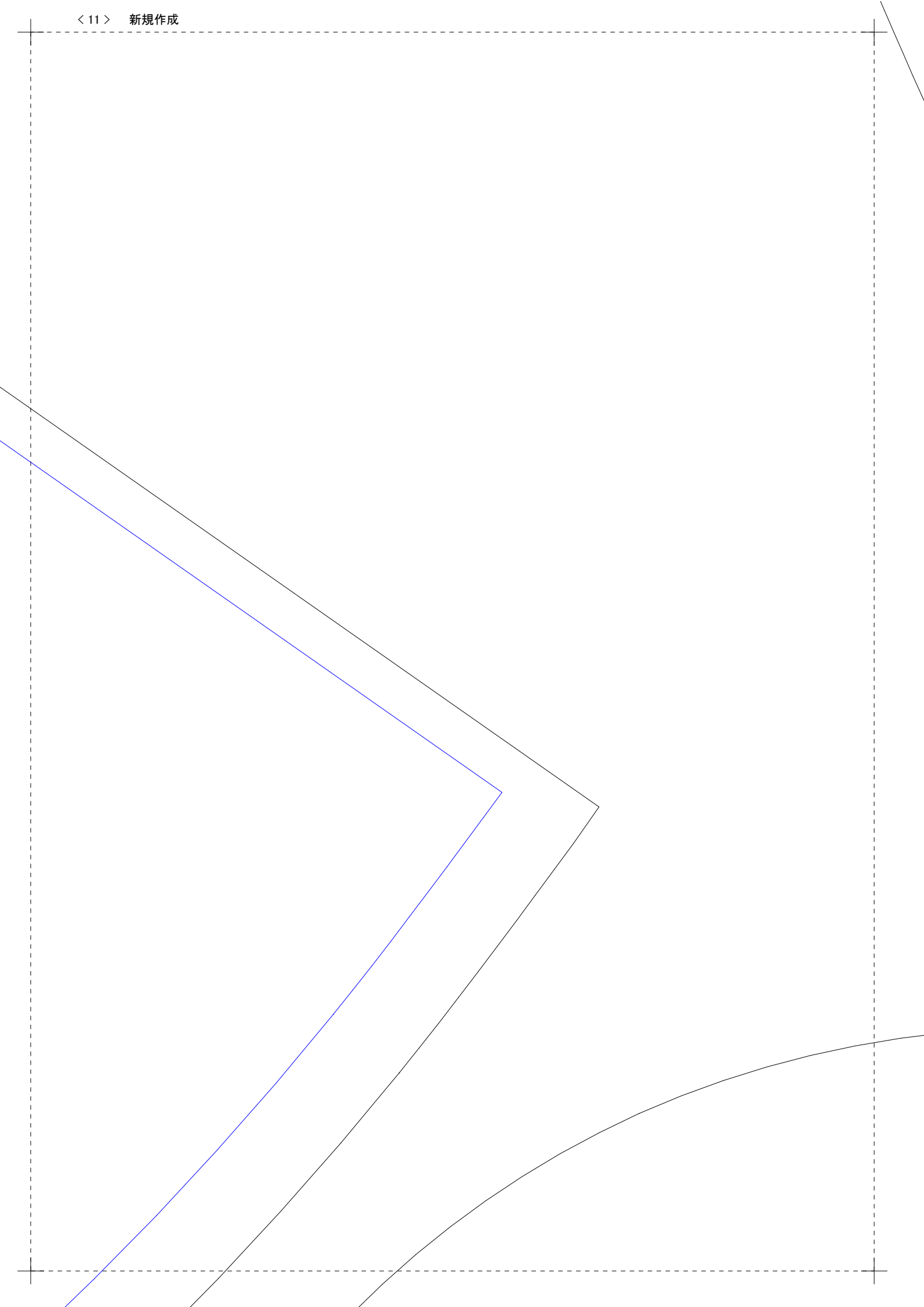

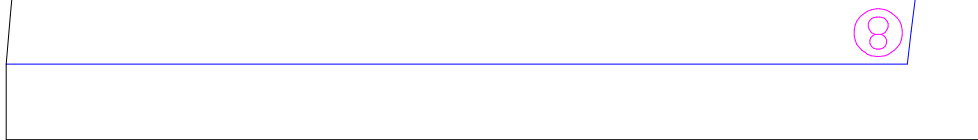
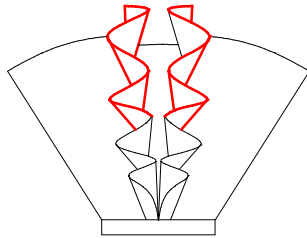

⑨

③

前フリルスカート
出来上がりウエスト69cm
ウエストベルト
1枚

⑥

⑤

10分の1サイズです

テープで貼り合わせると縫う手順がわかりやすくなります

10分の1で書いた布幅の上に配置すると

布の量の計算が簡単に出来ます

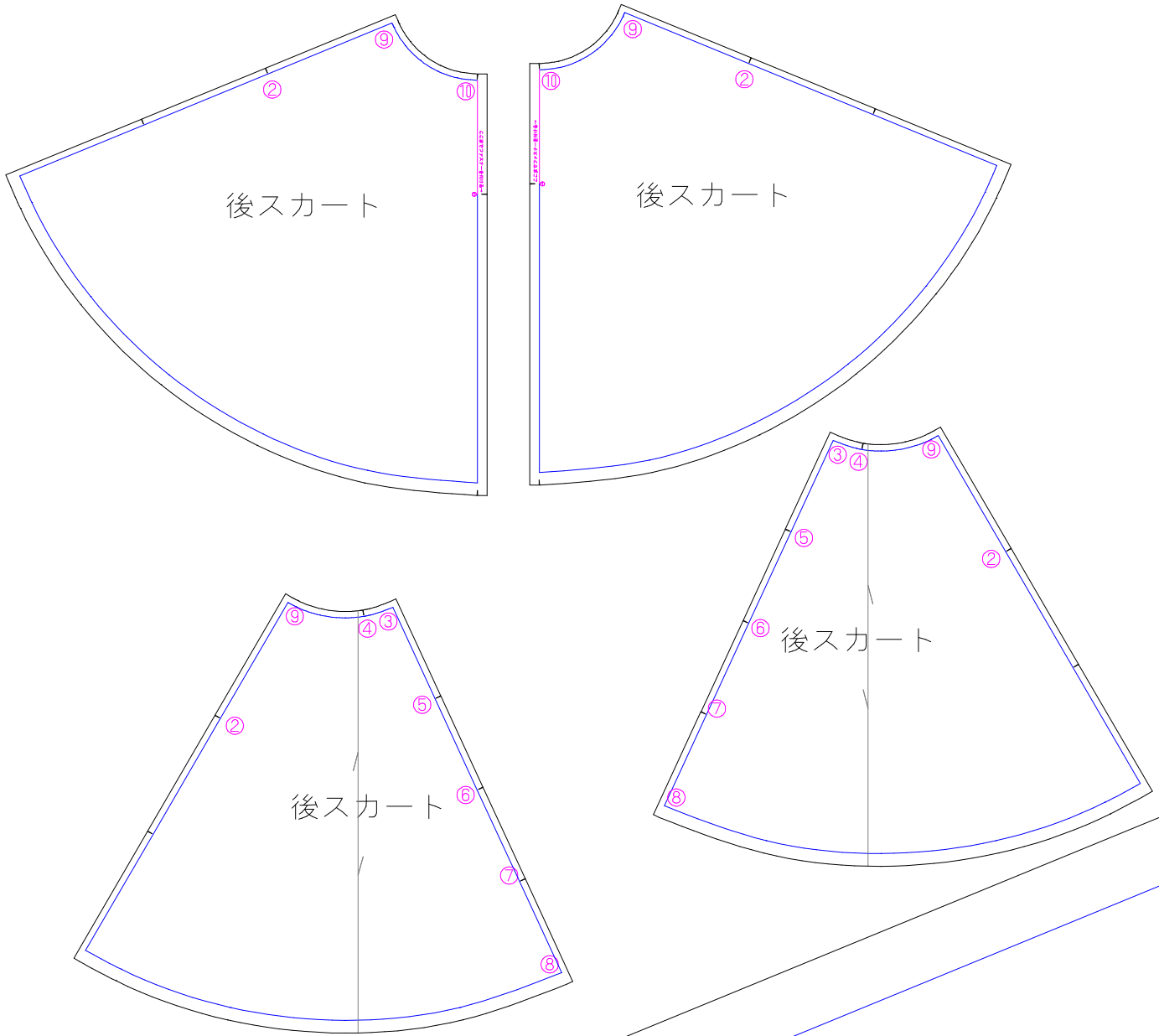

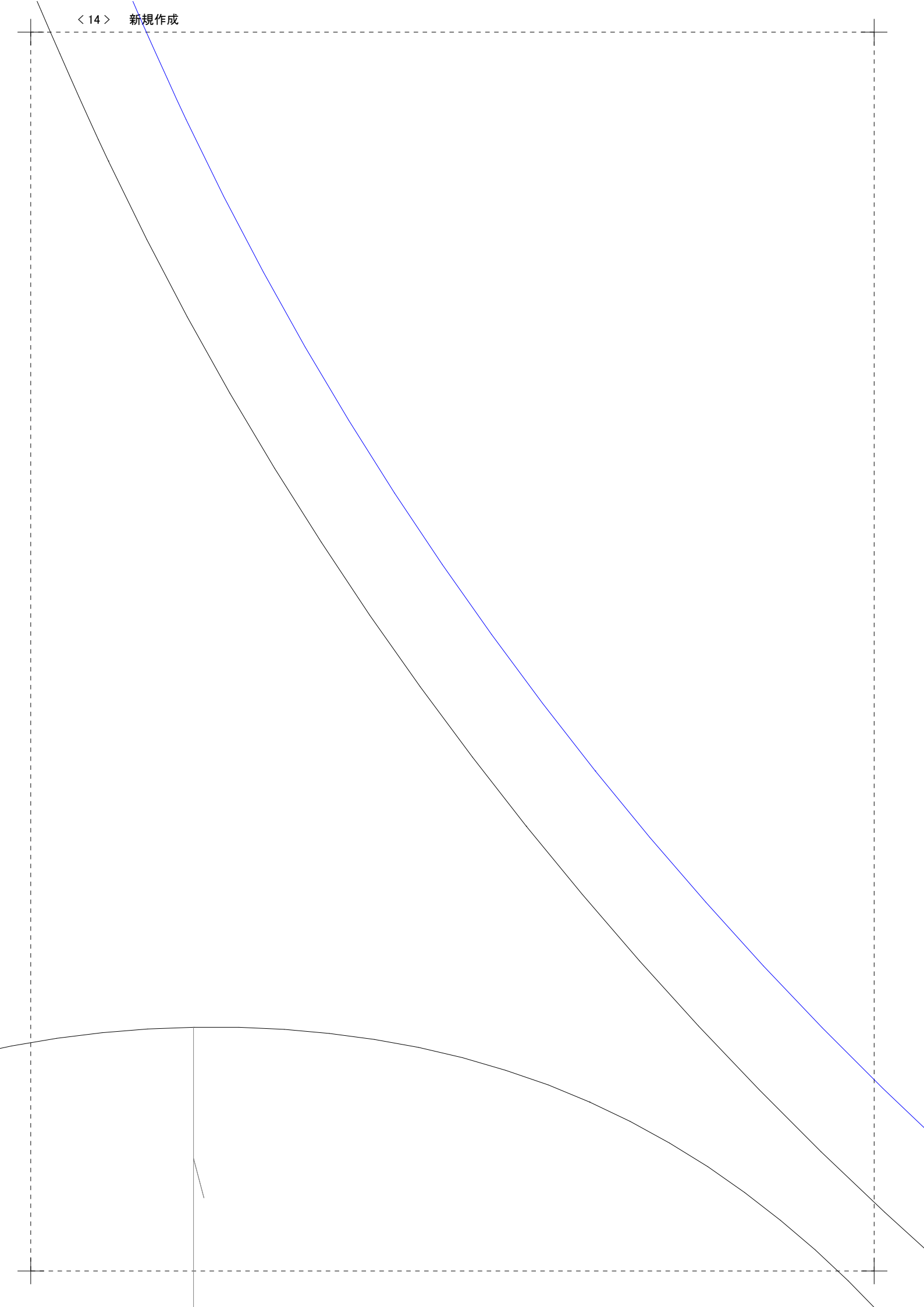

左右対称に2枚

下段ワイル

出来上がりウエスト69cm

前ワイルスカット

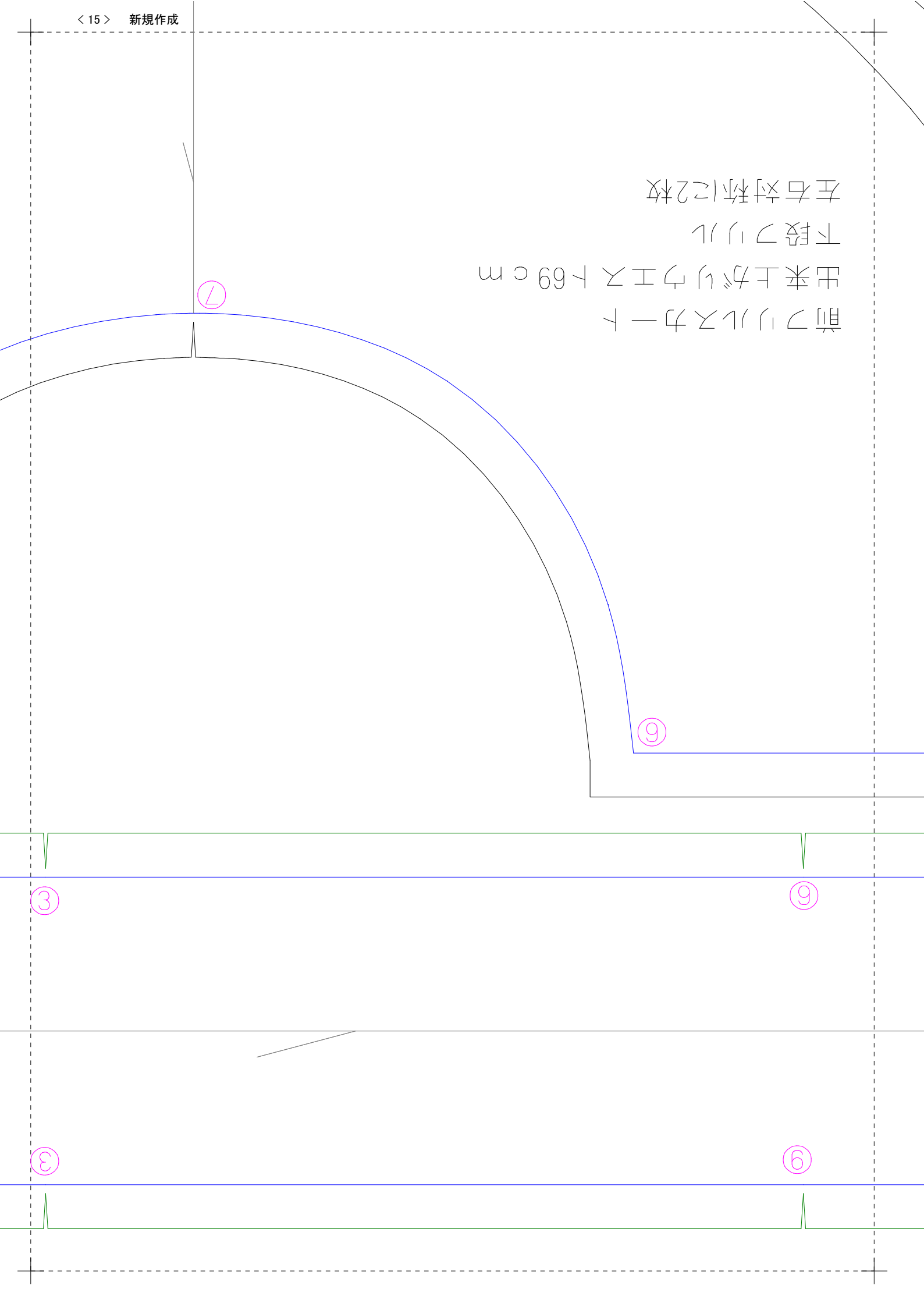

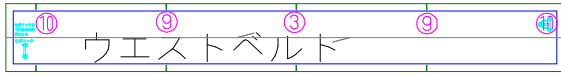
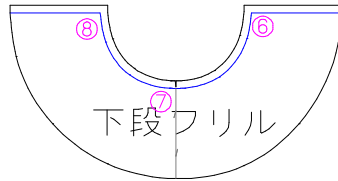
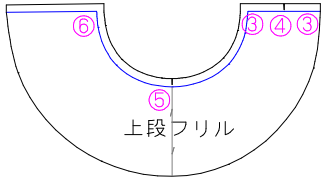
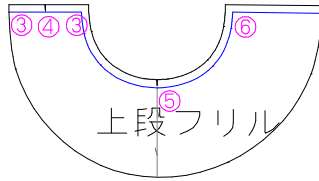
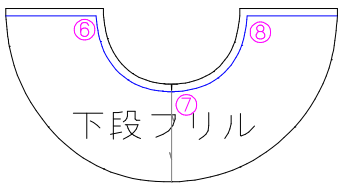

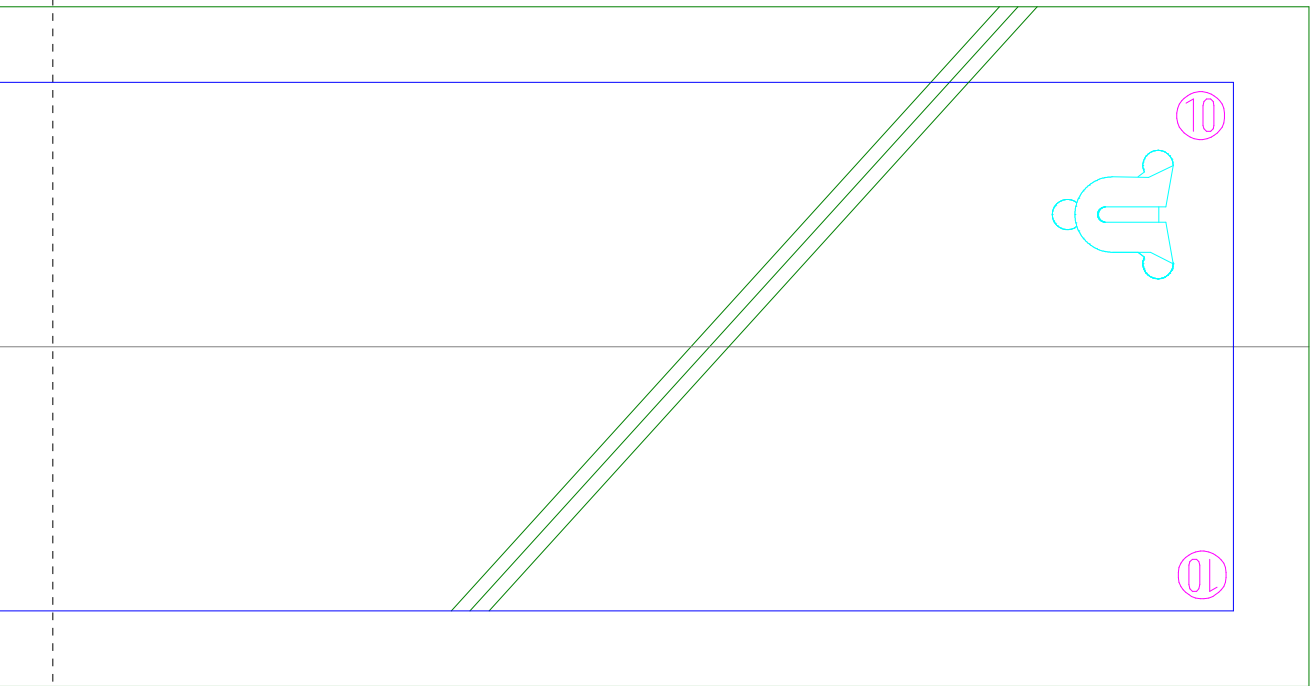
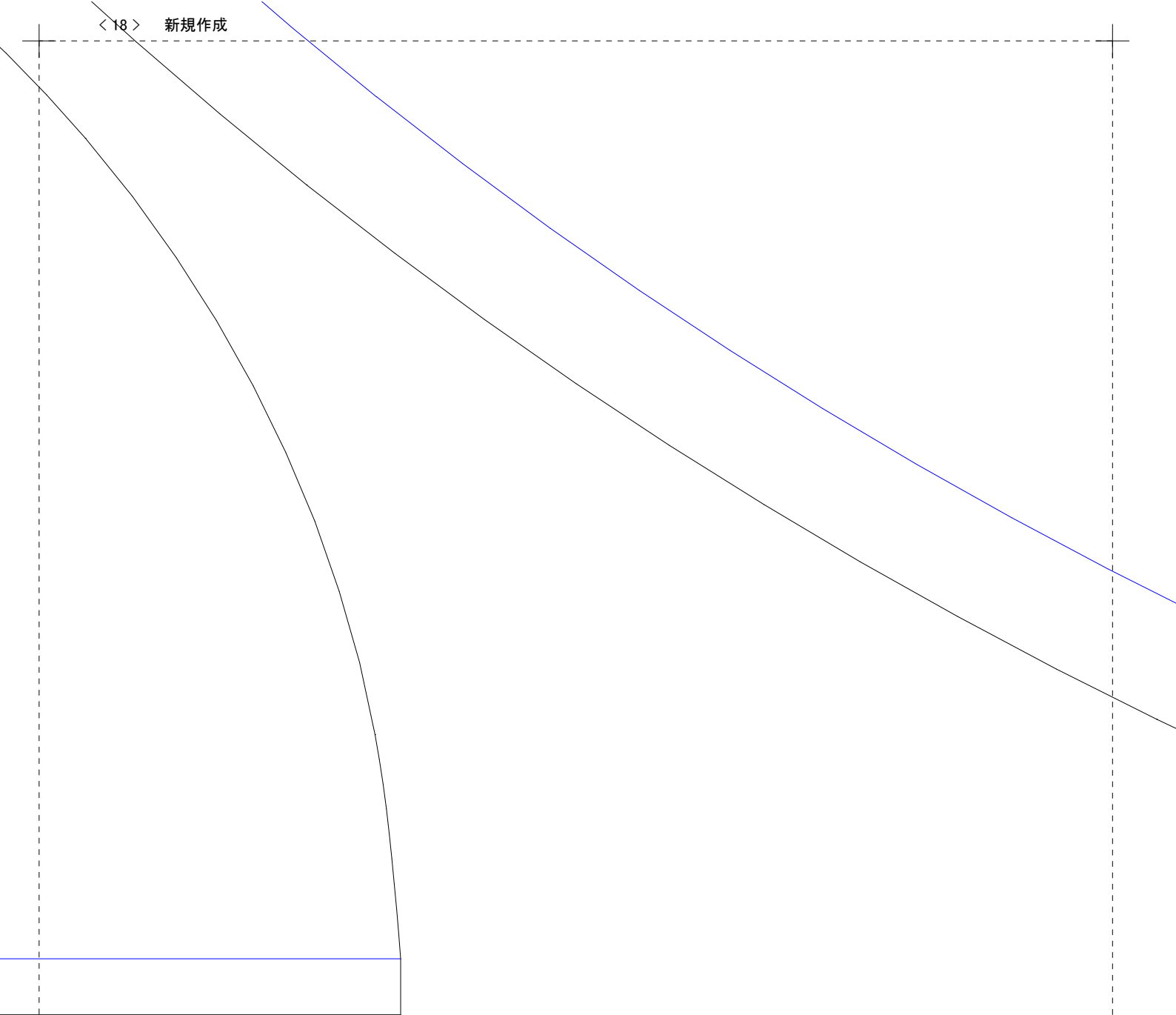

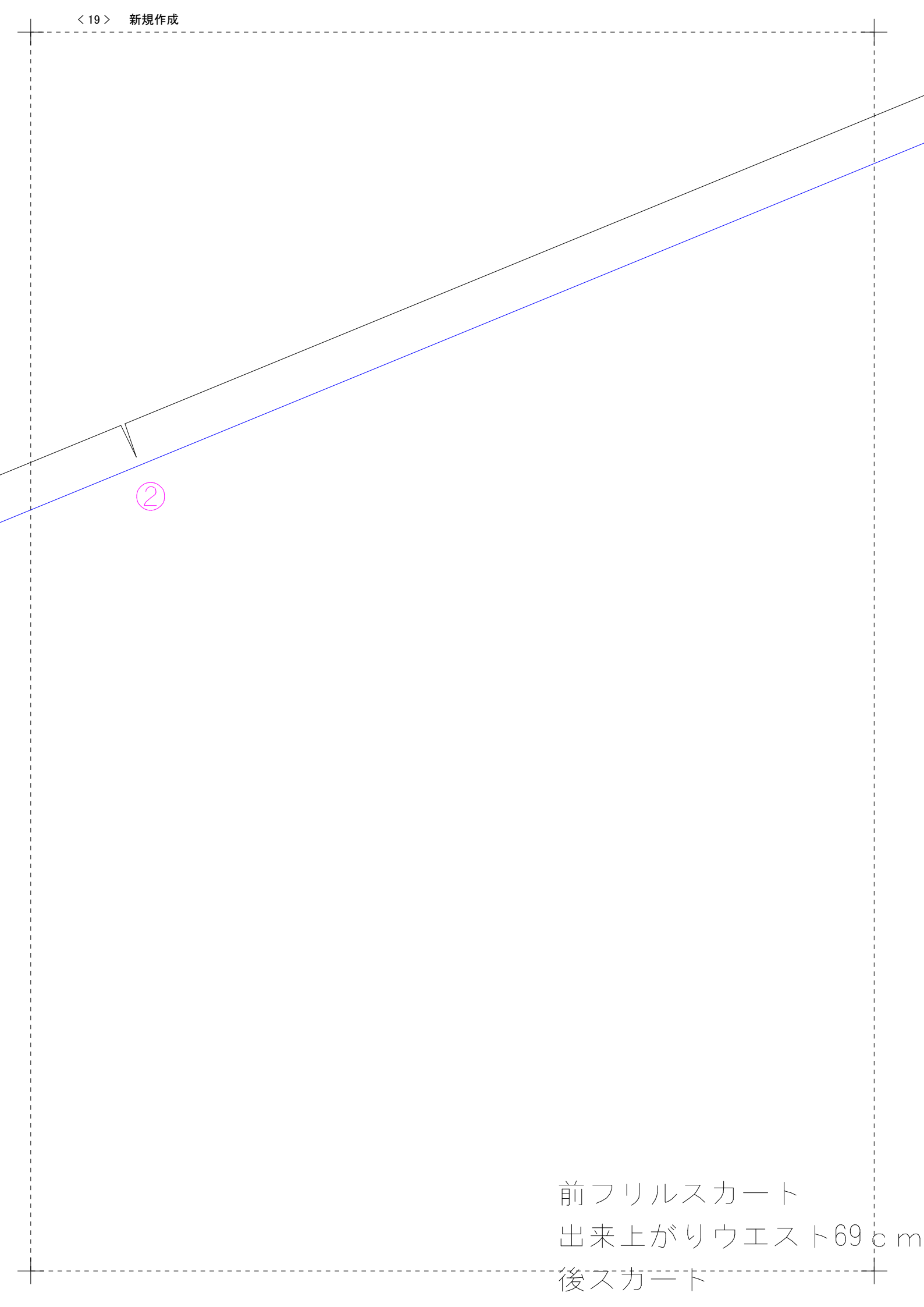

前フリルスカート

出来上がりウエスト69cm

後スカート

後スカート
左右対称に2枚

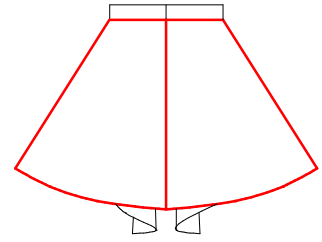

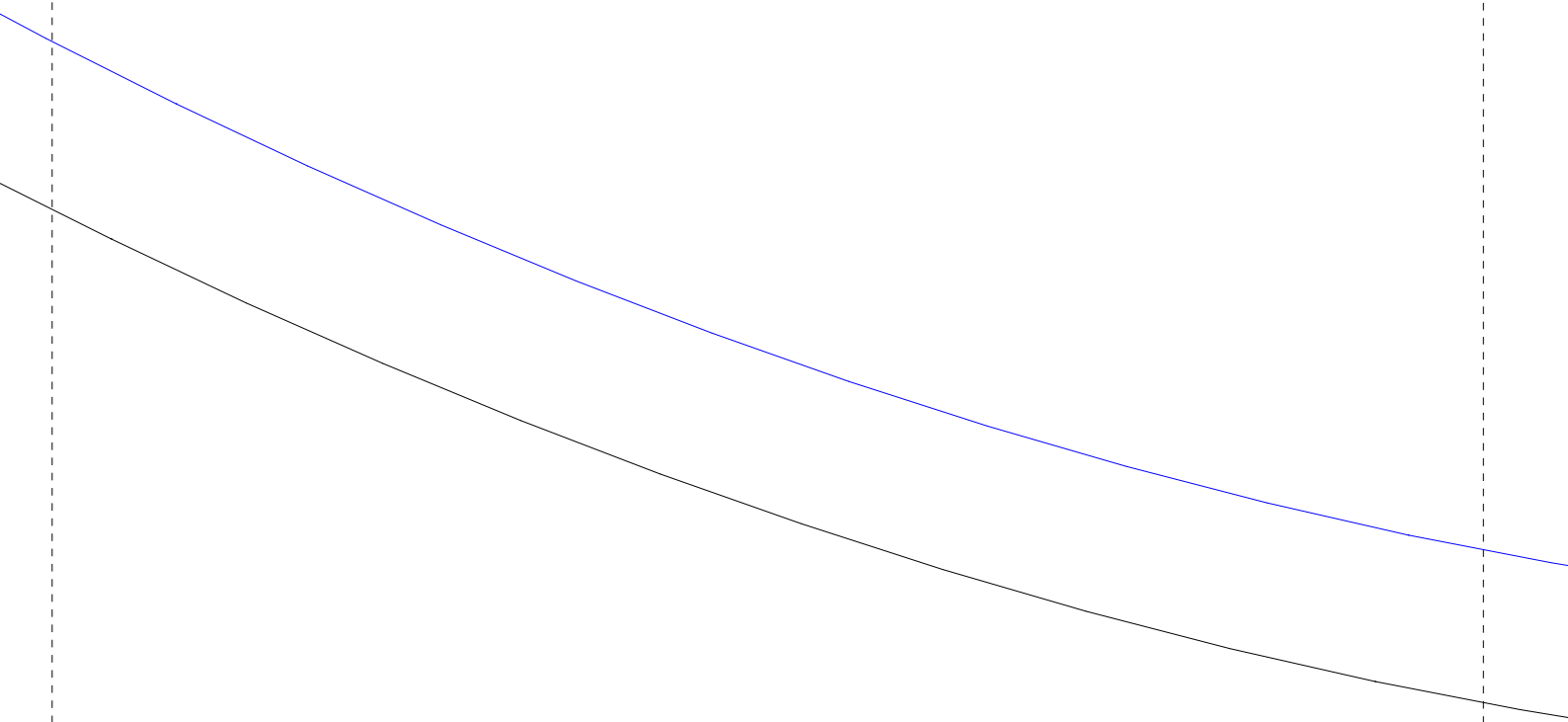

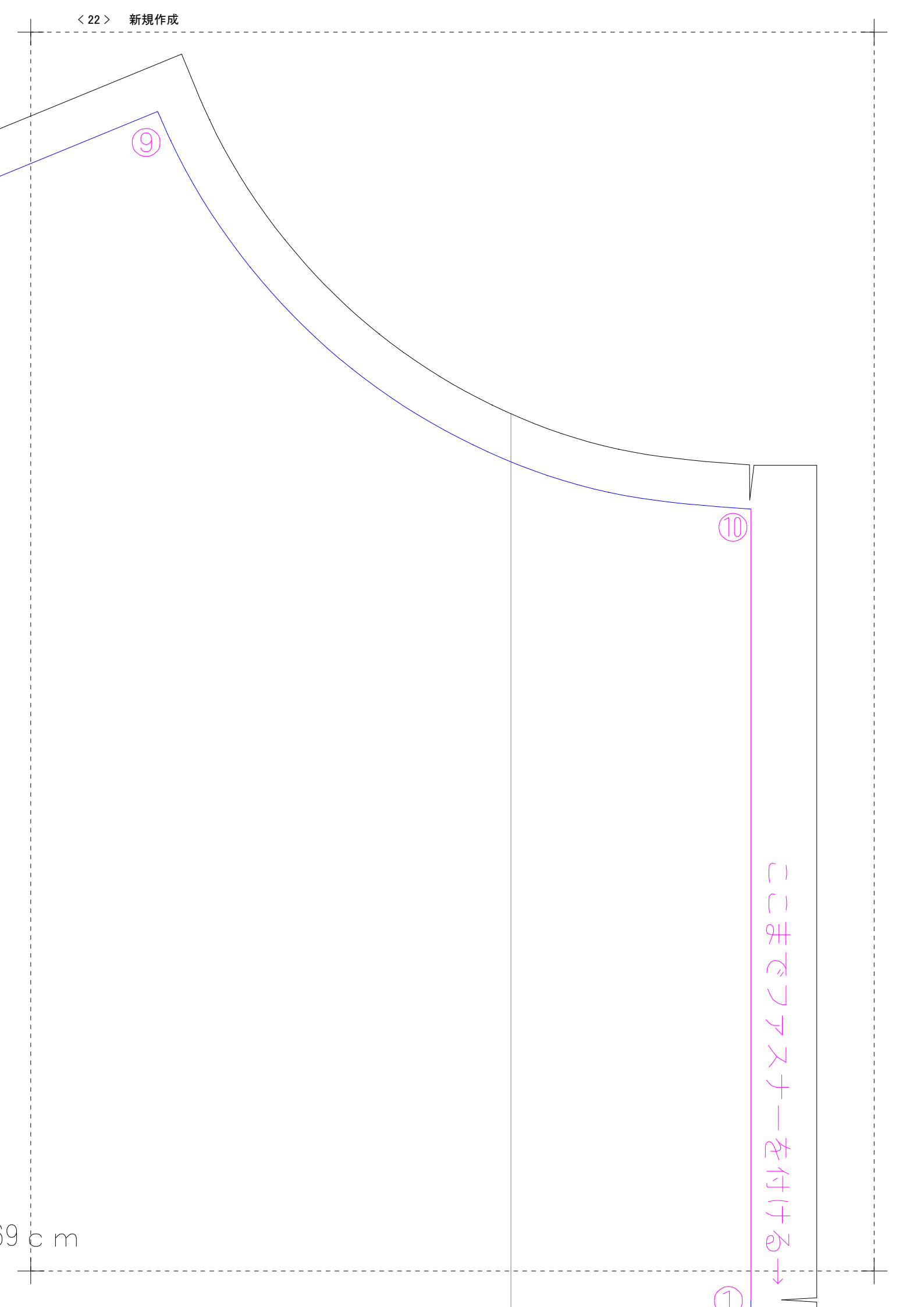

59 c m

ここまでフラスナーを付ける→

①

5



